

# INFINITY<sup>26</sup>

## USER MANUAL

QM33001 • VERSION 1.1



 **Handi Quilter**®

Designed by a Quilter, for Quilters.®

# INFINITY<sup>26</sup>

## USER MANUAL

QM33001 • VERSION 1.1



© 2015 Handi Quilter, Inc. All rights reserved.

The information contained in this document is subject to change without notice. If you find any problems in the manual, please report them to us in writing. This document is not warranted to be error-free. Handi Quilter, Inc. assumes no responsibility or liability for any errors or inaccuracies that may appear in the informational content contained in this manual.

Handi Quilter, HQ Infinity, HQ Avanti, HQ Fusion, HQ Sixteen, HQ Sweet Sixteen, HQ Pro-Stitcher, and TruStitch are either trademarks or registered trademarks of Handi Quilter, Inc.





Printed in the United States of America.

Part number: QM33001

02//2015

# How to Use This Manual

## Notes, Important Notes, and Cautions

-  **NOTE:** A NOTE indicates important information that helps you make better use of your Handi Quilter product.
-  **IMPORTANT:** An IMPORTANT note provides information that is essential to properly using your Handi Quilter product.
-  **CAUTION:** A CAUTION indicates a potential for causing harm to your quilting machine, the quilt, or to yourself.
-  **ONLINE:** Indicates there is more information online, such as a video.

## Finding Information

### What are you looking for?

### Find it here

Warranty information.....	<i>Owner's manual</i>
Safety information.....	<i>Owner's manual</i>
Regulatory information.....	<i>Owner's manual</i>
What's included with your machine.....	<i>Owner's manual</i>
Machine specifications.....	<i>Owner's manual</i>
Frame setup information.....	<i>Gallery Frame installation manual</i>
Machine setup information.....	<i>Owner's manual</i>
How to thread your machine.....	<i>Quick reference card</i>
Needle system for your machine.....	<i>Quick reference card</i>
Getting started with quilting.....	<i>Getting Started videos</i>
Online videos.....	<i>www.handiquilter.com/videocatalog/</i>
Basic maintenance.....	<i>Owner's manual</i>
Troubleshooting.....	<i>Owner's manual</i>
Tips and tricks.....	<i>www.handiquilter.com/webinar/ www.handiquilter.com/videocatalog/</i>
Training and education options.....	<i>www.handiquilter.com/education/overview/</i>
Customer Care / Technical Support.....	<i>1-877-MY-QUILT (697-8458) or 801-292-7988 Available 8:00 AM to 5:00 PM Mountain Time, Monday to Friday HQcares@handiquilter.com</i>
Community.....	<i>Forum: www.handiquilter.com/forum/ Blog: www.handiquilter.com/blog/ Facebook: www.facebook.com/HandiQuilter</i>
Non-English versions of this manual (when available).....	<i>www.handiquilter.com/manuals/</i>

# Contents

<b>How to Use This Manual</b> .....	2
<b>Congratulations on Your Purchase!</b> .....	5
What's Included With Your Machine.....	5
<b>Important Safety Information (English)</b> .....	6
<b>About Your Machine</b> .....	9
General Specifications.....	9
Get to Know Your Infinity.....	10
<b>Installation and Setup</b> .....	13
Carriage.....	13
Power Cord.....	13
Handlebars.....	14
Touch-Screen Displays.....	18
Thread Tray and Thread Mast.....	20
Install the Quilt-View™ Video Camera with Quilter's Eye Technology.....	21
Optional Accessory: Easy-Click™ Ruler Base.....	23
Install the Laser Stylus.....	24
<b>Using Your Machine</b> .....	27
Power Switch.....	27
Lighting.....	27
Machine Needle.....	27
Hopping Feet.....	29
Optional Accessory: Couching Feet.....	30
Bobbin and Bobbin Tension.....	30
Easy-Touch Tension™.....	32
Threading the Machine.....	34
<b>Quilting With the Infinity</b> .....	36
Preparing to Quilt.....	36
Free-Motion Quilting.....	38
Micro Quilting.....	38
Optional Computer-Guided Quilting: HQ Pro-Stitcher®.....	38
<b>Using the Touch-Screen Displays</b> .....	40
Overview of the Main Screen.....	41
Stitching Modes.....	43
<b>Toolbar Options</b> .....	48
Using the Quilt-View™ Video Camera.....	48
Controlling the Lights.....	48



<b>Machine Tools</b> .....	<b>50</b>
Quilting Timer, Alarm, and Stitch Counter.....	50
On-screen Calculator .....	52
Software Updates .....	52
Calibrate Tension .....	55
Diagnostics .....	55
<b>Machine Settings</b> .....	<b>56</b>
Easy-Touch Tension™ Presets .....	57
Low-Bobbin Alarm .....	58
Handlebar Button Options .....	60
Laser Lights.....	62
Alarms .....	63
Tieoffs.....	64
Set Language .....	64
<b>Information Screens</b> .....	<b>65</b>
<b>Machine Maintenance</b> .....	<b>68</b>
Clean and Oil Your Infinity .....	68
Maintenance Schedule.....	69
<b>Troubleshooting</b> .....	<b>70</b>
<b>Appendix 1</b> .....	<b>76</b>
Federal Communications Commissions (FCC) Declaration of Conformity (For USA Only).....	76
Canadian Department of Communications Compliance Statement (For Canada Only).....	76
Radio Interference (Other than USA and Canada) .....	76
<b>Appendix 2: QR Codes for HQ Infinity Videos</b> .....	<b>77</b>
<b>Warranty</b> .....	<b>83</b>
<b>Warranty Registration Card</b> .....	<b>85</b>
<b>Machine Setup and Training Checklist and Certificate</b> .....	<b>87</b>

# Congratulations On Your Purchase!

You haven't just purchased a quilting machine, you've joined the Handi Quilter family and we welcome you. You have acquired the most advanced quilting machine available in today's market.

Handi Quilter is committed to innovation, reliability, customer service, and education. Our machines are *Designed by a Quilter, for Quilters*® and we are committed to your quilting success. With that in mind, we invite you to bookmark our website: [www.HandiQuilter.com](http://www.HandiQuilter.com) and invite you to visit to learn more about the art of quilting. We've posted videos on subjects as diverse as *Oiling Your Machine* to *Loading a Quilt* to *Making Perfect Feathers*. Your new quilting friends are already there, waiting for you! Remember, if you ever have questions, your local HQ authorized representative can help you. If the representative is not available, contact Handi Quilter directly at [HQCares@HandiQuilter.com](mailto:HQCares@HandiQuilter.com) or by calling us at 1-877-697-8458, Monday through Friday, 8:00 AM to 5:00 PM Mountain Time.

Keep the carton and packing materials. You will need them if you need to return the machine to the dealer or send it for repair. If you don't pack the machine properly or if you don't use the correct packaging materials, the machine could be damaged. Handi Quilter is not liable for damage that occurs during return shipping.

- **IMPORTANT:** These packaging materials are designed to prevent the machine from being damaged. Keep them in case you need to bring this machine to the dealer or send it for repair.

## What's Included With Your Machine

- Bobbins (5 pieces)
- Needle (134 MR) size 18 (pack of 10)
- Bobbin Case
- Thread tray and thread mast
- EZ Pen Oiler
- Screwdriver
- Power Cord
- 2.5 mm hex wrench
- 3 mm hex wrench
- 4 mm hex wrench
- 5 mm hex wrench
- Needle (134 MR) size 16 (pack of 10)
- Laser Stylus and Clamp
- Laser Stylus Bracket and Post
- Quilt-view™ Video Camera
- Open-toe Handi Foot (Ruler foot installed)
- Handlebar lever
- Getting Started DVDs
- User Manual
- Quick Reference Card
- HQ Bobbin Winder
- HQ Infinity Quilting Machine (including carriage, front and rear handlebars, front and rear displays, cables)

# Important Safety Information

This device complies with Part 15 of the FCC Rules. Operation is subject to the following two conditions: (1) This device may not cause harmful interference, and (2) this device must accept any interference received, including interference that may cause undesired operation. See the full Declaration of Conformity in the Appendix.

- **IMPORTANT:** Do not operate your HQ Infinity quilting machine until you have completely read the information contained in this manual. Please keep all packaging and order information for warranty purposes.

## IMPORTANT SAFETY INSTRUCTIONS

Read all instructions before using this machine.

When using this machine, basic safety precautions should always be followed, including the following:

### **DANGER** — To reduce the risk of electric shock:

- A quilting machine should never be left unattended when plugged in. Always unplug the machine from the electrical outlet immediately after using and before cleaning.

### **WARNING** — To reduce the risk of burns, fire, electric shock, or injury to persons:

- The HQ Infinity is heavy. Never attempt to lift it alone. Always use two people when lifting. Always lift from the throat of the machine, not from the handlebars.
- Always unplug the HQ Infinity from the electrical outlet when performing any maintenance, changing the needle, removing thread locks, or when left unattended.
- Do not unplug by pulling on cord. To unplug, grasp the plug, not the cord.
- Keep fingers away from all moving parts. Use caution around the needle or sharp external components.
- Change the needle often. Do not use bent or dull needles. “Every quilt deserves a new needle”.
- Switch the machine to the symbol off, or 0, position to turn it off when making any adjustments in the needle area, such as threading needle, changing needle, threading bobbin, changing hopping foot, and so forth.
- Never drop or insert foreign objects into any opening.
- The HQ Infinity should only be used indoors away from moisture.
- The HQ Infinity should not be stored or used in extreme temperatures.
- Use the HQ Infinity only for its intended use as described in this manual.
- To disconnect from the wall outlet, push the switch to the off position, then remove the plug from outlet pulling from the plug, not the cord. Never operate the HQ Infinity if the cord is damaged or not working correctly. If a mechanical or electrical problem is encountered, return the HQ Infinity to the nearest authorized service center or the manufacturer for examination, repair, electrical, or mechanical adjustment.
- It is not recommended that the HQ Infinity quilting machine be used with any machine quilting frame other than those recommended by Handi Quilter.

- Use this quilting machine only for its intended use as described in this manual. Use only attachments recommended by the manufacturer as contained in this manual.
- Never operate the machine with any air openings blocked. Keep ventilation openings of the machine free from the accumulation of lint, dust, and loose cloth.
- Do not operate where aerosol (spray) products are being used or where oxygen is being administered.
- Do not pull or push the machine across the fabric excessively while stitching. It may deflect the needle enough to cause it to break.
- Use only needles designed for free motion quilting and recommended by Handi Quilter for this machine. Other types of needles may break during normal quilting.
- Children shall not play with the machine. Close attention is necessary when this machine is used by or near children.
- This sewing machine may be used by children age 8 years and above and persons with reduced physical, sensory, or mental capabilities or lack of experience and knowledge if they have been given supervision or instruction concerning use of the machine in a safe way and understand the hazards involved.
- Cleaning and user maintenance shall not be made by children without supervision.

## Save these instructions.

This machine is intended for household or commercial use.

## Disclaimer

Handi Quilter and its Representatives are in no way legally responsible or liable for damage to the HQ Infinity when used improperly or not in accordance with the guidelines stated in this manual or when used on machine quilting frames not recommended by Handi Quilter.

## To use the machine safely

1. Carefully watch the needle when sewing. Do not touch the hand wheel, take up lever, needle, or other moving parts.
2. Turn the machine off and unplug the cord in the following cases:
  - when you have stopped using the machine
  - when you replace or remove the needle or any other part
  - when you check or clean the machine
  - when you leave the machine unattended
3. Connect the machine directly to the wall outlet or to a surge protector that connects directly to the wall outlet. Do not use extension cords.

## To increase the life of your machine

1. Do not store this machine in areas exposed to direct sunlight or high humidity. Never use or store the machine near a heater, an iron, a halogen lamp or other hot things.

2. Use only neutral soaps or detergents to clean the machine. Benzene, solvents and scouring powders can damage the case and the machine and therefore should never be used.
3. Do not drop or bump the machine.
4. Always consult the manual to replace or fix the hopping foot, needle or any other part of the machine. If necessary contact an authorized Handi Quilter representative or Handi Quilter technical support.

## Optional U.S. Grounding for Customers with 120 VAC Connections

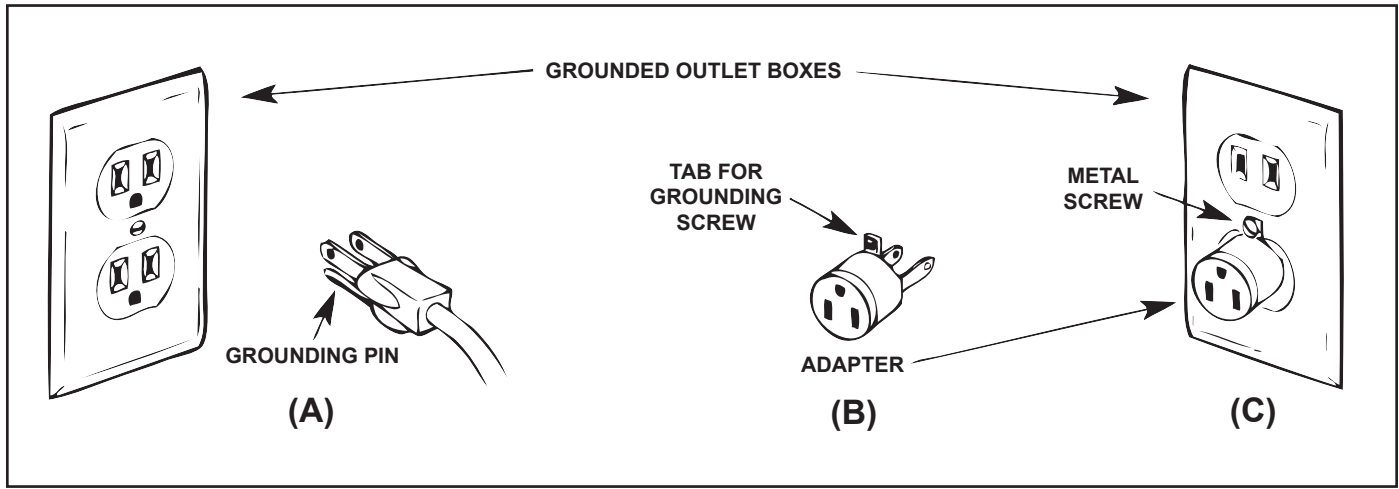

This product is for use on a nominal 120 V or nominal 220 V circuit, and has a grounding plug that looks like the plug illustrated in sketch A above. A temporary adapter, which looks like the adapter illustrated in sketches B and C, may be used to connect this plug to a 2-pole receptacle as shown in sketch B if a properly grounded outlet is not available. The temporary adapter should be used only until a properly grounded outlet can be installed by a qualified electrician. The green colored rigid ear, lug, and the like, extending from the adapter, must be connected to a permanent ground such as a properly grounded outlet box cover. Whenever the adapter is used, it must be held in place by the metal screw.

➡ **IMPORTANT:** In Canada, the use of a temporary adapter is not permitted by the Canadian Electric Code.

## To repair or adjust the machine

If the machine breaks down or needs adjustment, first check the troubleshooting chart in the appendix to inspect and adjust the machine yourself.

For more product information and updates, visit our website at [www.HandiQuilter.com](http://www.HandiQuilter.com).

The contents of this manual and product specifications are subject to change without prior notice. Check for updated manuals at [www.handiquilter.com/manuals/](http://www.handiquilter.com/manuals/).

# About Your Machine

## General Specifications

The HQ Infinity uses high-tech electronics and an innovative touch-screen user interface to offer greater functionality and ease of operation to home quilters than ever before conceived in the quilting industry. The HQ Infinity quilting machine is a high quality machine that both incorporates robust design features and is easy to service.

Sewing Opening Dimensions	(260 mm X 660 mm) 10.25 inches X 26 inches
Sewing Speed	Manual Mode: from 25 stitches per minute to 3100 stitches per minute Regulated Mode: from 0 stitches per minute to full speed
Stitches Per Inch	5 stitches per inch to 24 stitches per inch Basting mode: one stitch per quarter inch, one stitch per half inch, one stitch per inch, one stitch every two inches, and one stitch every four inches
Needle System	134MR
Needle Sizes (recommended)	From 80/12 to 130/21
Hook System	Rotary, Horizontal Axis, M-class bobbin
Bobbin Type	Aluminum, Class M
Bobbin Case	Type MF
Motor Type	Brushless DC
Needle Positioning	Up and down, walking stitch, on-screen hand wheel
Electrical Power	
US/Canada*:	105 – 120 VAC, 47-63Hz, 600W peak
Rest of world:	100 – 250 VAC, 47-63Hz, 600W peak
	* Complies with international certifications
Sew Foot Stroke/Lift	5 mm
Needle Bar Stroke	35.3 mm
Take-Up Stroke	73 mm
Lubrication, main components	Kluber Lube, permanent
Lubrication of hook	Velocite 10, Texaco 22

# Get to Know Your Infinity

Left side view

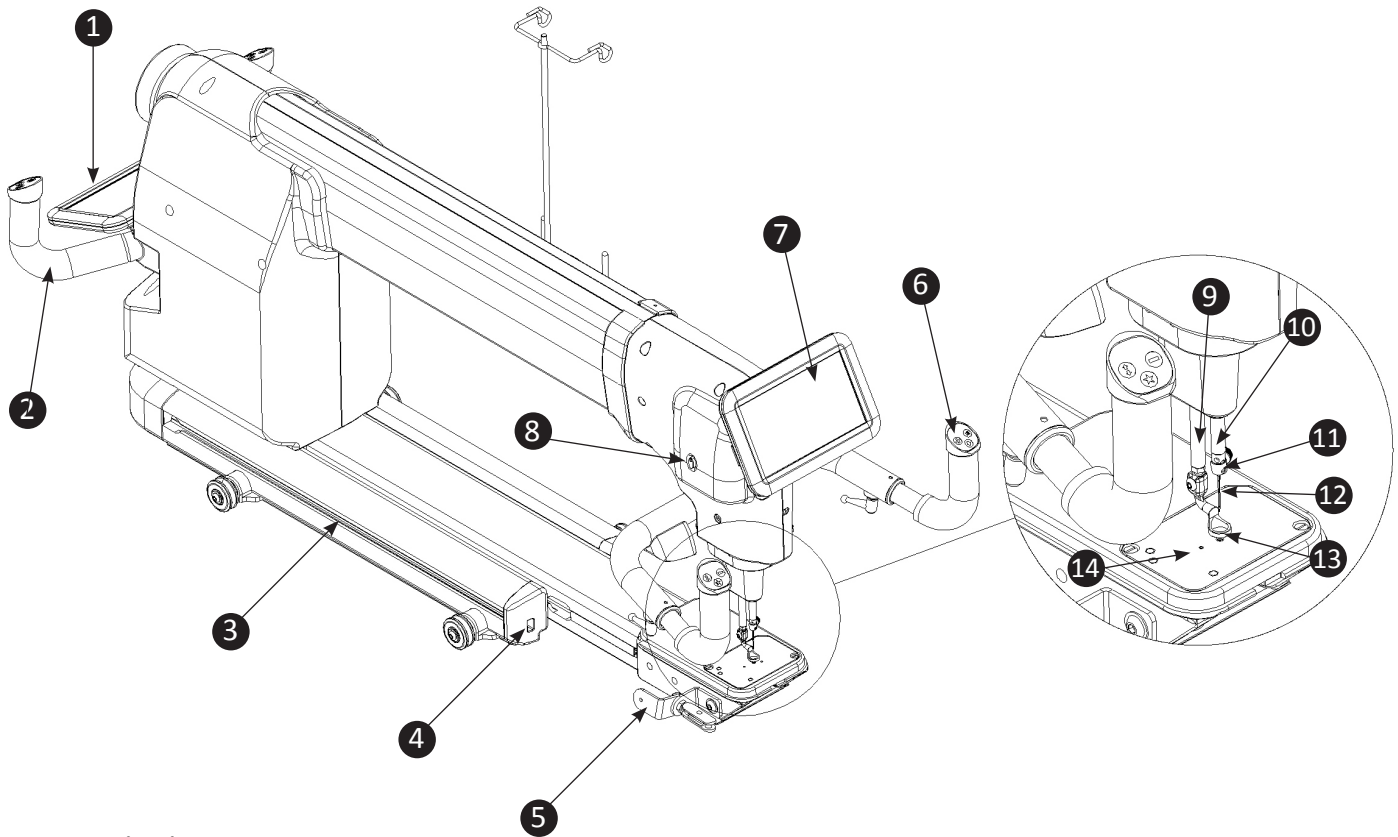

1. Rear display
2. Rear handlebars
3. Handi Accessory Rail
4. USB for video camera
5. Video camera bracket
6. Front handlebars
7. Front display
8. Front on/off switch

## Close-up view of needle area

9. Presser bar
10. Needle bar
11. Needle bar thread guide
12. Needle
13. Ruler foot
14. Needle plate

## Right side view

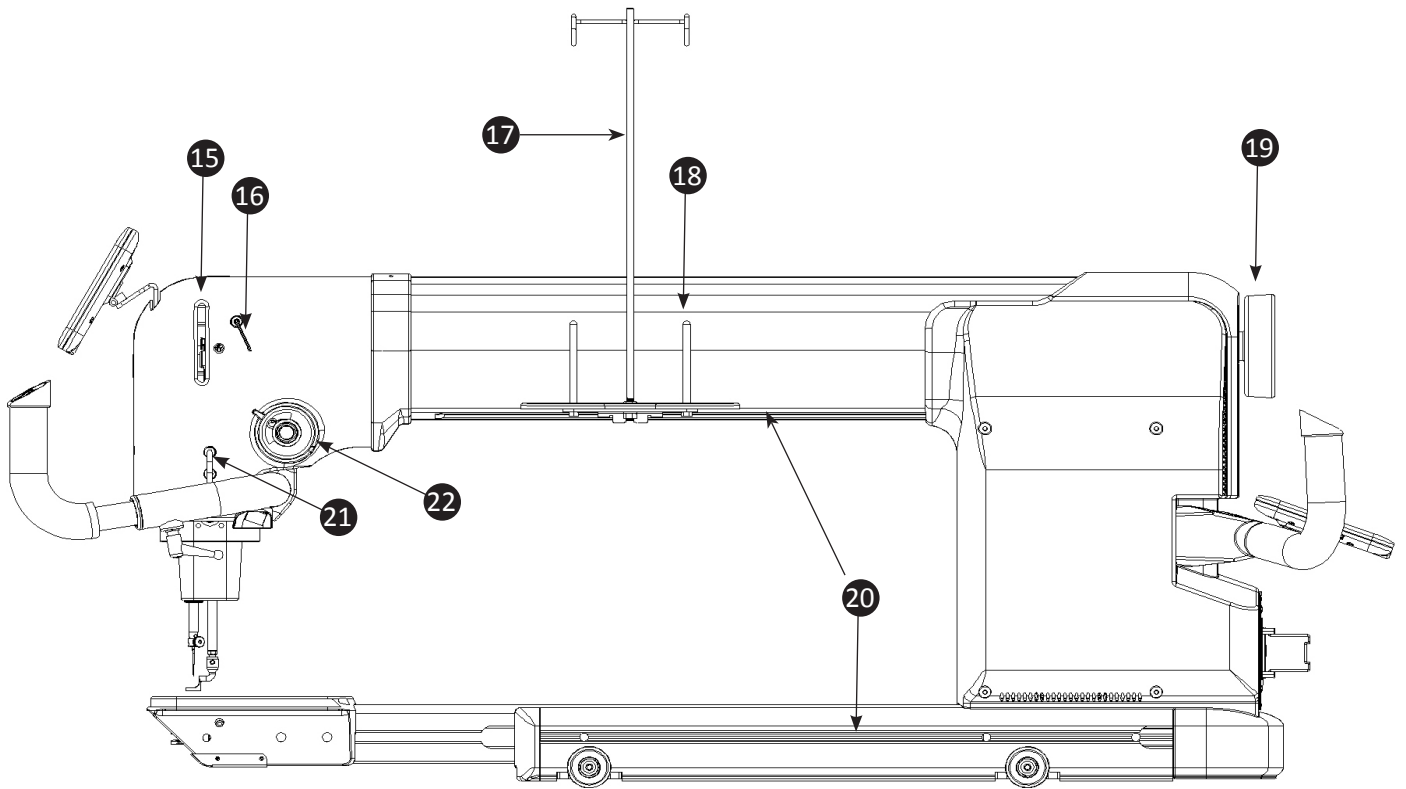

- 15. Take-up lever
- 16. Three-hole thread guide
- 17. Thread tray and thread mast
- 18. Spool pin
- 19. Hand wheel
- 20. Handi Accessory Rail
- 21. Stirrup thread guide
- 22. Tension assembly



## Back Panel

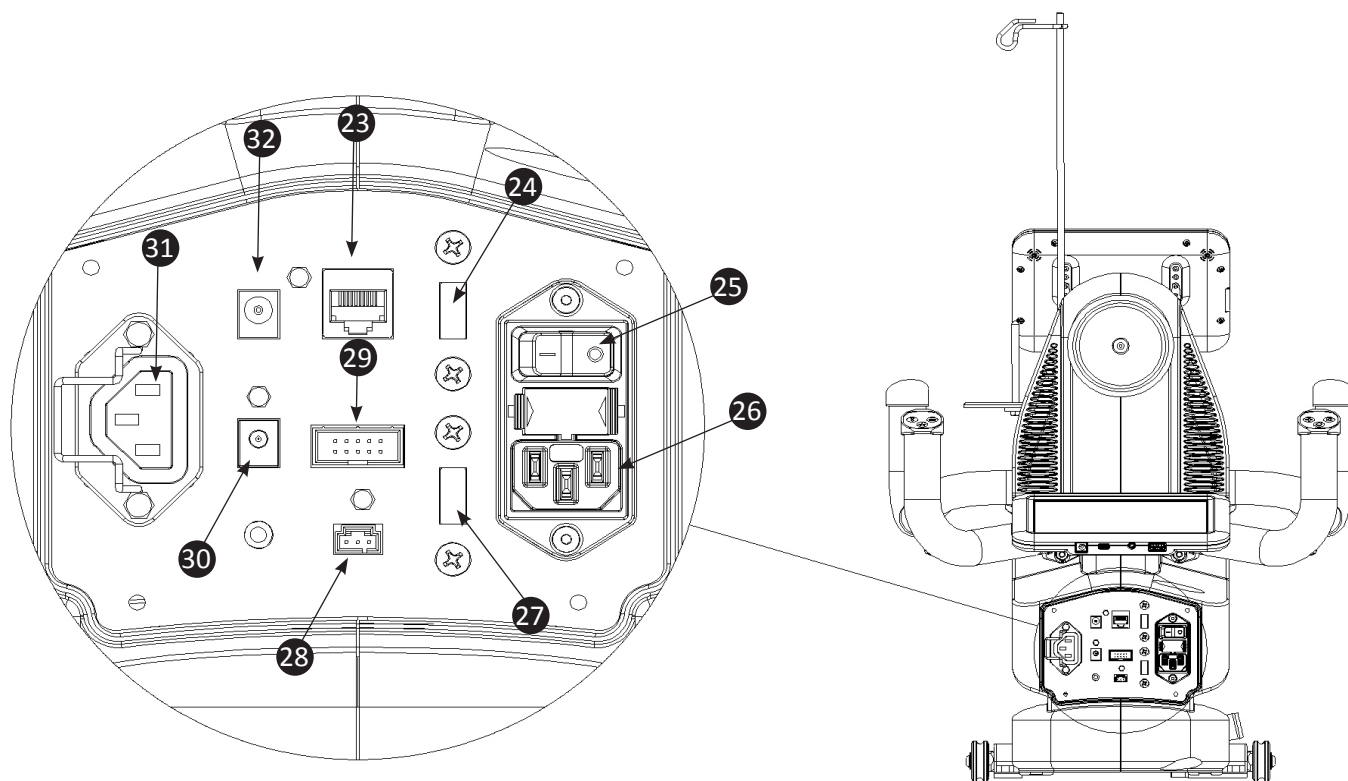

- 23. Rear handlebars connection
- 24. Rear display USB connection
- 25. Main On/Off power switch
- 26. Power cord connection
- 27. Reserved for second video camera
- 28. Reserved for HQ Pro-Stitcher
- 29. Stitch regulator
- 30. Laser stylus connection
- 31. Reserved for HQ Pro-Stitcher power
- 32. Rear display power connection

# Installation and Setup

## Carriage

You should have already set up the Gallery Frame. Refer to the Gallery Frame manual for detailed instructions about setting up the frame.

📺 **ONLINE:** For more information about setting up the frame, watch the video *Setting Up the Frame* at: <http://www.handiquilter.com/videos/hq-infinity/209/>.

### *To install the carriage and machine on the frame*

1. Place the carriage on the table rails, ensuring that the stitch regulator faces the back of the frame.
2. Place the machine on the carriage.
  - ⚠ **CAUTION:** The HQ Infinity is heavy. Never attempt to lift it alone. Always use two people when lifting. Always lift from the throat of the machine, not from the handlebars or needle bar.
3. Plug the ribbon cable from the stitch regulator connector at the back of the machine into the stitch regulator on the carriage.

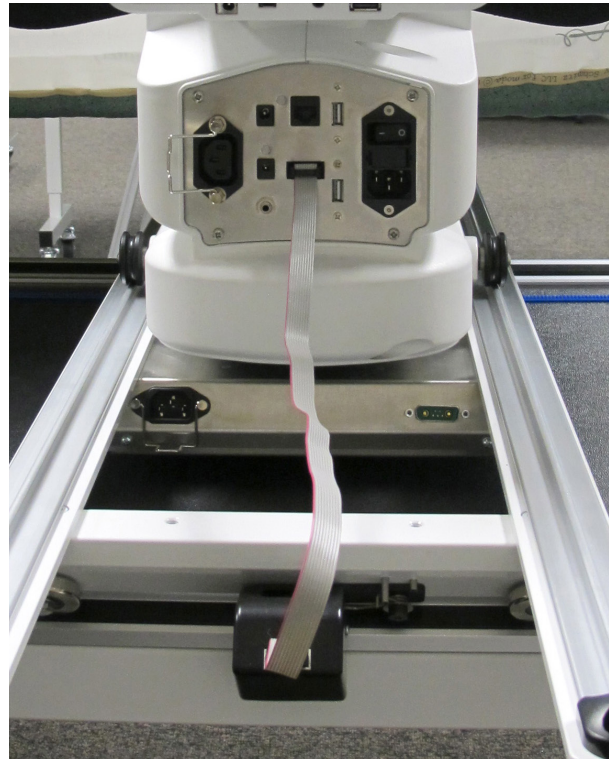

- 🔑 **IMPORTANT:** If you ever need to remove the machine from the carriage, disconnect the ribbon cable from the stitch regulator. Failure to unplug the cable when removing the machine from the carriage could result in damage to the cable, encoders, and carriage.

## Power Cord

### *To install the power cord*

- Insert the cord into the power connector on the rear of the machine. Plug the three-prong end into power source. Do not turn on the machine until the handlebars and display are installed.

### **To disconnect the power cord**

- Press the red button on the end of the cord that connects to the machine; then pull out the cord.

For more information, see *Power Switch* in the *Using Your Machine* section of this manual.

- ✎ **NOTE:** Make sure that the machine is off before plugging into power source. The rear power switch should be in the 0, or off, position.

## **Handlebars**

The Infinity has handlebars at both the front and back of the machine. You'll use the back handlebars for pantographs and Groovy, or pattern, boards, and will use the front handlebars for most other quilting activities.

For more information about using the touch-screen displays, see *Using the Touch-Screen Displays* later in this section of the manual.

- ⚠ **CAUTION:** To prevent any electrical damage to the handlebars, always turn off all power to the machine when connecting or disconnecting the handlebars.

### **To install the front handlebars**

- 📺 **ONLINE:** For more information about installing the front handlebars, watch the video *Installing the Front Handlebars* at: <http://www.handiquilter.com/videos/hq-infinity/210/>.

1. Locate the three hex screws for the front handlebars (two M5 and one M6 hex screw), a 5mm washer, a 6mm washer, and both the 4mm and 5mm hex wrenches.

- ➡ **IMPORTANT:** A handlebar bolt is also provided for you to use instead of the 5mm hex screw. This enables you to easily hand-loosen the bottom screw to adjust the angle of the handlebars to switch between micro quilting and regular quilting.

- ✎ **NOTE:** If you choose to use the lever bolt, you will lose approximately three-fourths of an inch of quilting space near the take-up pole.



2. Connect the RJ45, or network style, phone cords into the handlebars. Ensure that the cable exiting the right side of the machine head plugs into the left handlebar lighting connector and the cable exiting the left side of the machine head plugs into the right side of the handle bar.



3. Place the 5mm washer on the M5 hex screws and place into the top two holes in the handlebar bracket.



4. Align the bracket and hex screws with the pre-drilled holes behind the machine's head and fully tighten the top two screws with the 4mm hex wrench.

 **NOTE:** You may find it is easier to remove the front poles from the Gallery frame so you can position yourself behind the machine's head.

5. Place the 6mm washer on the M6 hex screw and insert it into the bottom hole and partially tighten. Alternately, you can use the extra handlebar lever.



- Adjust the handlebars forward or backward to a comfortable position for quilting and tighten the bottom screw with the 5mm hex wrench. If using the handlebar lever, fully hand-tighten.

➡ **IMPORTANT:** See To attach labels to the handlebars in the section *Configurable Handlebar Buttons* below.



### **To install the rear handlebars**

📺 **ONLINE:** For more information about installing the rear handlebars, watch the video *Installing the Rear Handlebars* at: <http://www.handiquilter.com/videos/hq-infinity/211/>.

- Locate the four 4mm hex screws for the rear handlebars and the 4mm hex wrench.
- Align the four holes in the handlebars with the holes on the back of the machine.
- Slide the bolts into holes until they stop. Use the 4mm hex wrench to firmly tighten the bolts and securely fasten the handles to the back of the machine.
- Connect one end of the RJ45, or network style, phone cord into the handlebars and the other end into the machine's back panel.



➡ **IMPORTANT:** See *To attach labels to the handlebars* in the *Configurable handlebar buttons* topic below.

🔪 **NOTE:** After installing and plugging in the handlebars and the touch-screen displays, plug in the power cord and test them by turning on the machine using the rear on/off switch and then the on/off button on the left side of the machine. If nothing appears on the touch screen, check that the handlebar cables are plugged in securely, that your machine is turned on, and that the power cord is plugged into the machine as well as into a power source. If everything is working, turn off and unplug the machine and continue the installation.



## ***To adjust the hand-position angle of the front handlebars***

Rotate the angle of the handlebars to a comfortable position by using the two levers below the handlebars.

- 🔗 **ONLINE:** For more information about adjusting the position and angle of the front handlebars, watch the video *Adjusting the Position and Angle of the Handlebars* at: <http://www.handiquilter.com/videos/hq-infinity/212/>.
- Loosen the levers by turning them counterclockwise. Then grasp the front of the handlebars and adjust them inward or outward to a comfortable position for general quilting. Tighten the levers by turning them clockwise when you are happy with the position.

## ***To use the handlebars for micro quilting***

- 🔗 **ONLINE:** For more information about adjusting the position and angle of the front handlebars, watch the video *Adjusting the Position and Angle of the Handlebars* at: <http://www.handiquilter.com/videos/hq-infinity/212/>.
- 🔗 **ONLINE:** For more information about micro quilting, watch the video *Micro Quilting* at: <http://www.handiquilter.com/videos/hq-infinity/239/>.

When micro quilting, you'll want to have your hands (and therefore, handlebars) close to the quilt top. In addition to adjusting the angle of the front handlebars, you can adjust how closely positioned the handlebars are relative to the quilt.

- Use the 5mm hex tool to loosen the bolt at the back of the handlebars. Grasp the handlebars and tilt them closer to the quilt until they are in a comfortable position for micro quilting. Then tighten the bolt with the hex tool.
- ✍️ **NOTE:** If you expect to regularly alternate between regular quilting and micro quilting, we recommend that you replace the bottom bolt at the back of the front handlebars with the extra lever bolt that was provided. Use the 5mm hex tool to loosen and then remove the bottom bolt at the back of the handlebars. Screw in the extra lever bolt and finger tighten.

## **Configurable Handlebar Buttons**

The Infinity handlebars are configurable so you can decide which functions you want the left and right handlebar buttons to do when pressed. Once configured, the front and back handlebars work the same.

The machine comes from the Handi Quilter factory configured to have the right handlebar control starting and stopping quilting and increasing stitching speed in Manual mode or stitches per inch in Regulated mode. The left handlebar controls cycling the needle up and down and slowing the stitching speed or decreasing stitches per inch. However, you can switch the functions from one side to the other. You can also select from several functions and assign one to the star button and another to the diamond button. For example, choose to have the diamond button perform a bobbin-thread cut and the star button to perform a tieoff.

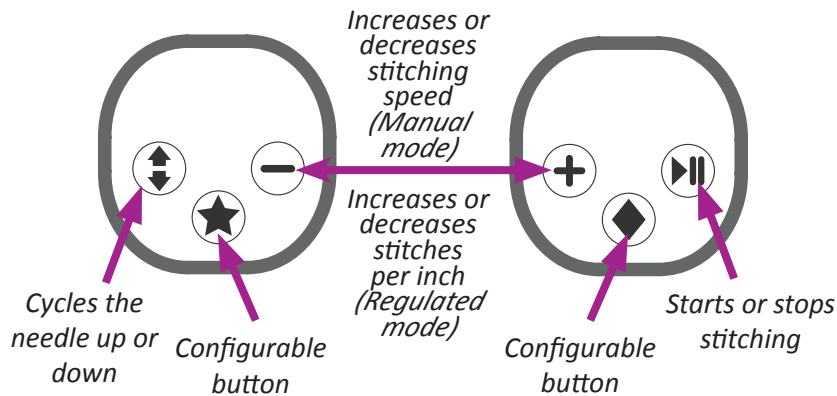

 **NOTE:** Pressing the plus or minus buttons on the handlebars also increases or decreases tension after you press the **Easy-Touch Tension™** button on the Main screen. As long as the Easy-Touch Tension button is enabled, pressing the plus or minus buttons controls the tension setting.

For more information about configuring the handlebars and buttons, see *To customize the handlebar buttons* in the *Toolbar Options* section of this manual.

Install the handlebar labels according to what you want each handlebar to do. For example, if you are right-handed, you may want the right handlebar to control starting and stopping the stitching.

 **NOTE:** The traditional handlebar configuration has the Start and Pause buttons on the right handlebar and the Needle Up and Down buttons on the left handlebar.

### **To attach labels to the handlebars**

 **CAUTION:** Be absolutely certain of your handlebar label choice before installing the labels. Once they are stuck down they cannot be removed without damaging the switch.

1. Peel off the paper backing off the labels and place them on the front handlebars according to how you plan to configure the functions.
2. Repeat for the rear handlebars, making sure that you match the placement from the front handlebars.

## **Touch-Screen Displays**

The Infinity comes with two identical 7-inch touch-screen displays – one for the front of the machine and one for the back of the machine.

### **To install the front display**

 **ONLINE:** For more information about installing the front display, watch the video *Installing the Front Display* at: <http://www.handiquilter.com/videos/hq-infinity/213/>.

1. Locate four 2.5mm screws and the 2.5mm hex wrench. You'll also need the display with the hinges attached to the bottom row of connectors on the back of the display, plus the longer set of display cables.

2. Insert the 2.5mm hex screws into the openings on the display's metal hinge. Align the screws in the hinge with the holes on the display bracket. Use the 2.5mm hex wrench to fully tighten the screws.



3. Plug the power and USB cables into the bottom of the display and into the front-left side of the Infinity.



- ➡ **IMPORTANT:** If you have HQ Pro-Stitcher, you will install the HQ Pro-Stitcher tablet computer to the front of the machine instead of the 7-inch display. See the instructions that come with HQ Pro-Stitcher for more information about installing the tablet computer.

### ***To install the rear display***

- 📺 **ONLINE:** For more information about installing the front display, watch the video *Installing the Rear Display* at: <http://www.handiquilter.com/videos/hq-infinity/214/>.

1. Locate four 2.5mm screws and the 2.5mm hex wrench. You'll also need the display with the hinges attached to the top row of connectors on the back of the display, plus the shorter set of display cables.



2. Insert the 2.5mm hex screws into the openings on the display's metal hinge. Align the screws in the hinge with the holes on the display bracket. Use the 2.5mm hex wrench to fully tighten the screws.



3. Plug the power and USB cables into the bottom of the display and into the rear panel on the machine.

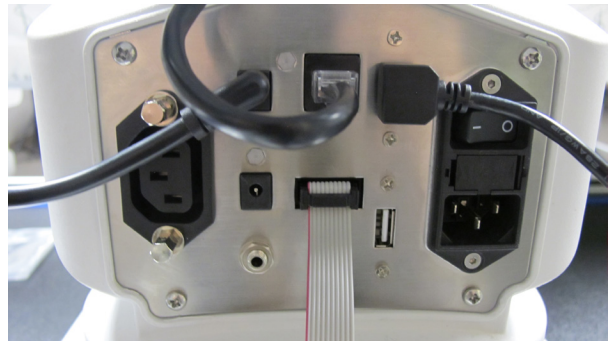

## Thread Tray and Thread Mast

### *To install the thread tray on the machine*

 **ONLINE:** For more information about installing the spool tray onto the machine, watch the video *Installing the Thread Tray* at: <http://www.handiquilter.com/videos/hq-infinity/216/>.

1. Locate the T-nut and the knob for the thread tray. If necessary, thread the T-nut onto the end of the knob a couple turns.
2. Align the T-nut with the opening at the front of the Handi Accessory Rail on the bottom of the machine's throat, insert into the track, and slide a few inches into the track.



3. Slide the slot of the spool tray onto the knob's bolt. Finger tighten the knob until the spool tray is firm against the throat of the machine.



### ***To adjust the position of the thread tray***

After the thread tray and thread mast are installed, you will be able to slide the tray and thread mast along the length of the machine.

- Loosen the knob at the bottom of the thread tray until the tray can move freely along the Handi Accessory Rail. Position the tray where you want it and finger tighten the knob.



## **Install the Quilt-View™ Video Camera with Quilter's Eye Technology**

A video camera comes with the Infinity. It is installed to preview the quilting on the backing of the quilt.

### ***To install the Quilt-View video camera***

- 📺 **ONLINE:** For more information about installing the video camera, watch the video *Installing the Video Camera* at: <http://www.handiquilter.com/videos/hq-infinity/218/>.

1. Partially loosen the side knob on the grip of the video camera and slide the grip around the ball end of the mounting screw on the bracket.
2. Turn the knob clockwise to tighten the grip end of the camera.



3. Position the camera so it shows the bottom of the quilt while quilting.
4. Plug the cable into the port on the left side of the base end cap.



5. Tuck the excess cable into the accessory track on the left side of the machine base and use a T-slot clip to hold the cable in place.

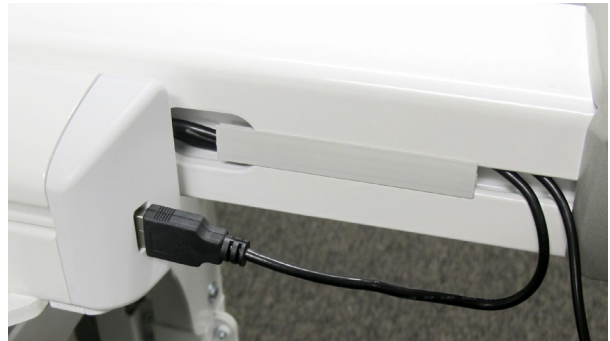

For more information about the using the video camera and viewing the video images on the display, see *Using the Video Camera* in the *Toolbar Options* section of this manual.

Use this dial to vary the intensity of the camera's lights.



Use this knob to control the camera's focus.

## Optional Accessory: Easy-Click Ruler Base™

If you plan to use rulers and templates with the Infinity, you will need to purchase the ruler base to give you a large, stable surface on which to rest the ruler or template. The ruler base and rulers and templates are optional accessories. For more information, visit <http://www.handiquilter.com/shop/>.

### To install the ruler base

 **ONLINE:** For more information about installing the ruler base, watch the video *Installing the Ruler Base* at: <http://www.handiquilter.com/videos/hq-infinity/219/>.

1. Center the ruler base over the base end cap of the machine. The spring-loaded ball bearing is aligned with the needle.
2. Slide the metal hooks of the ruler base into the slots at the back of the base end cap and snap the ruler base into place.

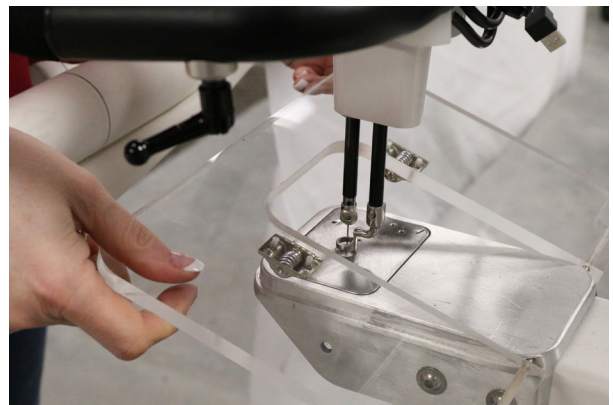

### To remove the ruler base

- Grasp the front corners of the ruler base and lift up to unsnap from the base end cap. Slide the ruler base forward and lift off of the machine.



## To use rulers and templates with your quilting machine

 **ONLINE:** For more information about using rulers and templates, watch the video *Using Rulers and Templates* at: <http://www.handiquilter.com/videos/hq-infinity/220/>.

 **CAUTION:** Use only one-quarter inch thick rulers with your machine. Do not use rotary-cutting rulers as they are too thin and can easily slip under the hopping foot. Always use a ruler base or extended table to stabilize the ruler.

Keep the ruler flat and quilt only where ruler is held securely. Avoid losing control by walking your hand along the ruler or stopping and repositioning your hand and the ruler.

- Apply gentle three-point pressure to the ruler, as follows.
  1. Press the ruler against any side of the hopping foot.
  2. Press machine against ruler.
  3. Press ruler against ruler base with only as much force as is necessary to keep the ruler from slipping. Too much pressure will keep the machine from moving.

The quilting line is approximately a quarter inch away from the ruler edge for most machines. The markings on all Handi Quilter rulers take this into consideration.

 **NOTE:** Set the machine to stop in the needle-down position to keep the machine from moving while making adjustments with the ruler.

## Install the Laser Stylus

The laser light (for use with paper pantographs) is installed on a mounting post that is attached to the accessory track along the right side of the machine.

### To install the mounting post and laser stylus

 **ONLINE:** For more information about installing the laser mounting post and laser stylus, watch the video *Installing the Laser Stylus* at: <http://www.handiquilter.com/videos/hq-infinity/221/>.

1. Locate the laser bracket with mounting post, the laser stylus, and the 5mm hex wrench.
2. Insert the T-nut on the laser bracket into the Handi Accessory Rail and slide into the rail.



3. Tighten the nut using the 5mm hex wrench. Slide the laser clamp onto the mounting post and tighten the two knobs on opposite sides of the clamp.

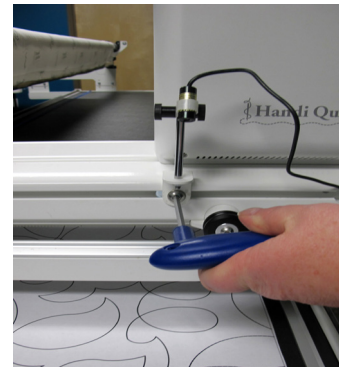

4. Plug the cable end into the laser stylus port on the back of the machine. Wrap the excess cable around the rear handlebars, or insert it into the Handi Accessory Rail and use the T-slot clip to secure.

Laser stylus port



The laser projects a straight laser beam visible as a dot on surfaces it hits. The laser dot is used as a guide or stylus enabling you to use printed pantograph designs and stitch the continuous pattern onto a quilt by tracing the design with the laser dot.

 **ONLINE:** For more information about quilting with pantographs, watch the video *Using Pantographs* at: <http://www.handiquilter.com/videos/hq-infinity/238/>.

The laser attaches to a mounting post which attaches to the accessory track along the right side of the machine. The laser stylus can move in any direction by rotating the clamp on the post and pivoting the laser up or down. To make an adjustment, simply loosen the black thumbscrews, position, and retighten.

 **IMPORTANT:** A label is attached to the laser's case and contains an arrow which indicates the direction the laser light will shine when energized. The label must remain in place on the laser. Removing the label voids the laser's warranty.

## Laser Operation and Safety

Turn the laser on and off using the machine setting option to turn on or off the laser lights. For more information about turning on and off the laser, see *To turn the lasers on or off* in the *Toolbar Options* section of this manual.

Be sure the laser is attached to the machine and pointed downward toward the table before connecting it to the port. Never point it in a direction that would project the beam into someone's eyes. If the laser should stop working, ensure the plug is firmly seated into the Infinity laser port.

## Laser Focus and Image Size

Focus the high-quality laser by turning the threaded housing surrounding the lens clockwise or counterclockwise. The laser image can be adjusted to project a bigger or smaller dot, or focal size. The direction of rotation needed is determined by the distance of the laser from the pantograph surface. Experiment by rotating the threaded end to achieve your desired focal size.

## Laser Safety

When using the laser stylus, observe the following basic safety precautions.

- Never shine directly into the eyes.
- The laser stylus should never be left on and unattended.
- Do not use the laser stylus as a toy.
- Pay close attention when the laser stylus is being used by or near children or pets.
- Use the laser stylus only for its intended use as described in this manual.

 **NOTE:** If you can't see the threaded housing, the lens may be threaded too far into the laser body. You will need to use a large slotted screwdriver to turn it counter clockwise until the housing is visible. You can then rotate it with your fingertips to bring the light into focus. Be very careful to not scratch the lens when using the screwdriver.

 **CAUTION:** Use of controls or adjustments or performance of procedures other than those specified herein may result in hazardous radiation exposure.

# Using Your Machine

## Power Switch

There are two power switches for your machine. The main power switch is at the rear of the machine and another power switch is at the front of the machine for added convenience.

The machine is turned on when both switches are turned on. The machine is turned off when both switches are off. However, you may turn off the machine functions by turning off only the front switch if you will be returning to quilting within a day.

Turn on the back switch first by toggling the switch from the 0 position to the 1 position. Then turn on the front switch by pressing it. The front switch will not turn on the machine unless the back switch is already on.

- **IMPORTANT:** If you will not be using the machine for more than a day, we recommend you turn off both switches and unplug the power cord from the power source.
- **IMPORTANT:** Refer to the safety instructions.

## Lighting

The Infinity includes several lights to make it easy for you to see your quilting area: a light under the throat of the machine, a light ring that illuminates the needle and stitching area, and lights on the handlebars that provide additional light to the quilting area. You can also turn on UV lights when you need to see white thread or white chalk on white fabric.

Turning the lights on and off is done through the touch-screen display. For more information about turning on the machine lights, see *To control the lights* on the machine in the *Toolbar Options* section of this manual.

## Machine Needle

Use only the recommended needle system for your Infinity quilting machine. The machine was timed to use this specific type of needle and it is designed to work with the high quilting speeds and multidirectional stitching the Infinity offers.



The Infinity uses the MR needle system. Note that the needle has a round shank rather than a shank with a flat side like home sewing machines use.



If you use the recommended needle, you will experience:

- Fewer skipped stitches
- Less needle breakage
- Less thread breakage, especially at high speeds
- Less thread splicing or shredding
- Optimum fabric protection

➡ **IMPORTANT:** Change the needle regularly. We recommend you use a new needle for each new quilt loaded on the machine, and any time the needle becomes bent, dull, or burred.

⚠ **CAUTION:** A damaged needle may result in poor stitching quality or may even damage the machine or your quilt.

### ***To change the needle***

📺 **ONLINE:** For more information about changing the needle, watch the video *Changing the Needle* at: <http://www.handiquilter.com/videos/hq-infinity/222/>.

1. Move the needle bar to the up position by pressing the needle up/down control on the handles.
2. Turn off all power to the machine.
3. Loosen the needle bar clamp screw with the 2.5mm hex wrench.

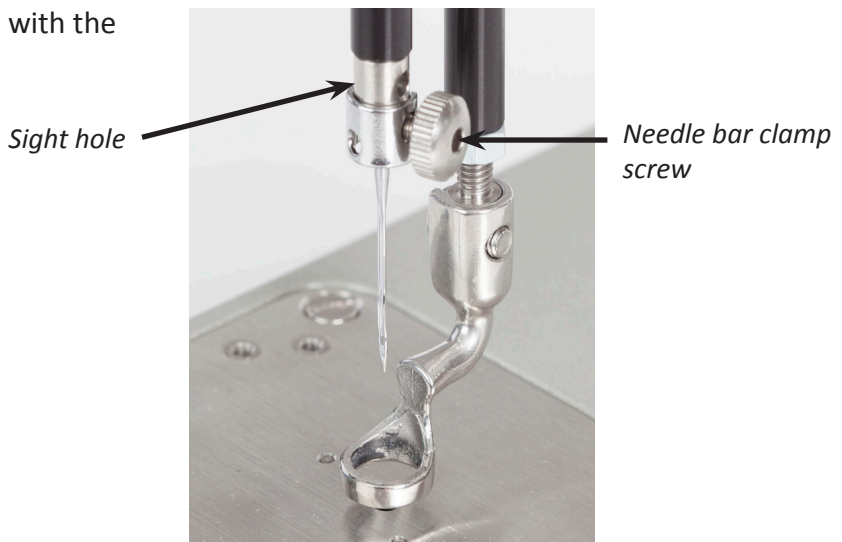

4. Remove the old needle by pulling it down. Discard the old needle in a safe way.

- With the scarf of the needle (indentation at the back of the needle) facing the rear of the machine and the long groove down the front of the needle facing the front of the machine, push the needle all the way up into the needle bar until it stops. Check the sight opening to verify that the top of the needle can go no farther up.

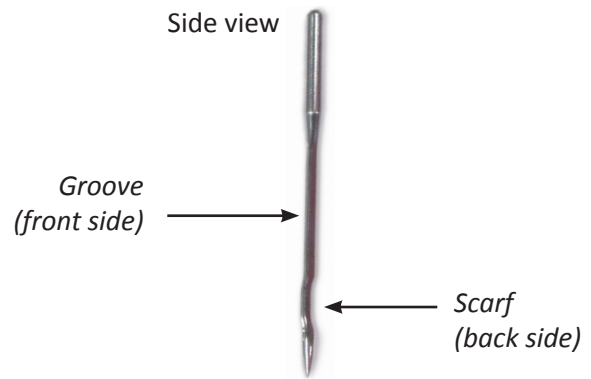

- CAUTION:** Check the needle to confirm it is fully inserted. The needle bar has a sight opening above the needle bar clamp screw. Make sure the needle is touching the top of the sight opening. If it isn't, the machine timing will be off and it may be possible for the needle to collide with internal parts causing damage not covered by warranty.

- Carefully tighten the needle bar clamp screw.

- CAUTION:** Although you can use your fingers to tighten the needle bar clamp screw, we recommend that after finger-tightening the screw you use the 2.5mm hex wrench to tighten it just a bit more. The Infinity runs at very high speeds and this ensures the needle will not loosen while quilting. However, do not over tighten the needle clamp screw as this may strip the threads of the screw. Stripped threads are not covered under the warranty. It may also become difficult to insert the needle properly into the needle bar. Once the screw no longer turns freely by hand, gently turn the screwdriver until the screw is tightened snugly.

Needle size	Thread size
12 and 14	monofilament, 100 wt. silk, 60 wt. poly, mylar
16	monofilament, hologram, 100 wt., 80 wt., 60 wt., 50 wt., 40 wt. silk, poly or cotton thread
18	40 wt. cottons and poly, 30 wt. cottons and poly
19 and 21	Any thread 30 wt. and heavier such as 12 wt., 19 wt., 30 wt.

### Machine Quilting Tip: Needle Requirements

For general quilting, a size 16/100 needle will accommodate most threads and fabrics. Heavier threads, such as top stitch and some decorative threads, require a larger needle such as 18/110 or 21/130. Lofty batts and heavier fabrics such as denim, canvas, or densely woven fabric may also require a larger needle.

## Hopping Feet

Your machine comes with two hopping feet: a ruler foot (comes installed) and an open-toe foot. Use the ruler foot for everyday quilting and ruler work, and use the open-toe foot when you need greater stitch visibility (such as when you are micro quilting).

- ONLINE:** For more information about changing the hopping foot, watch the video *Changing the Hopping Foot* at: <http://www.handiquilter.com/videos/hq-infinity/223/>.

## To change the hopping foot

1. Remove the foot that is on the mount by using the 2.5mm hex wrench to loosen the mounting screw far enough that you can slide the foot off of the mount.
2. Slide the desired foot onto the mount. Note that the opening on the side of the foot is lined up with the screw hole. Push the foot up as far as it will go.
3. Fully tighten the screw with the 2.5mm hex wrench.

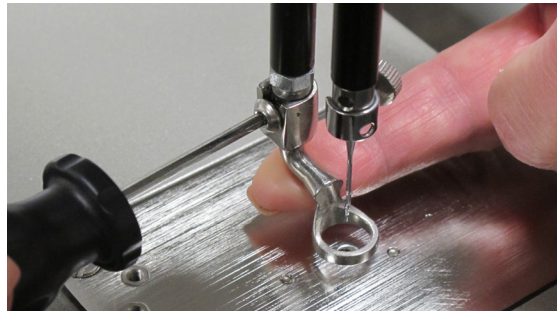

 **NOTE:** Before threading the needle, test that the machine is threaded properly and the tension is correct by carefully pulling the top thread. It should pull smoothly with light to medium tension. If thread pulls freely with no tension, rethread the machine, ensuring that the thread is flossed into the tension discs.

 **IMPORTANT:** The Infinity does not have a presser foot lever or top tension release like a home sewing machine. On a home sewing machine the top tension is released when the presser foot is raised, allowing the thread to come freely out of the machine. When a home machine is threaded the tension discs are released and open to allow the thread to easily fall between the tension discs. This isn't the case with the Infinity quilting machine. The top tension is always tight and the tension discs are never open. Therefore the thread must be pulled up, or flossed, between the tension discs or it will stay outside the discs and float without tension, causing serious tension problems and/or thread nests.

## Optional Accessory: Couching Feet

 **ONLINE:** For information about using the optional couching feet, watch the video *Using the Couching Feet* at: <http://www.handiquilter.com/videos/hq-infinity/224/>.

## Bobbin and Bobbin Tension

The Infinity quilting machine uses M-class bobbins that are larger than sewing machine L-class bobbins. The larger bobbins enable you to quilt for a longer time between bobbin changes.

The Infinity also has a low-bobbin alarm. For more information about the low-bobbin alarm, see *To configure the low-bobbin alarm settings* in the *Toolbar Options* section of this manual.

### ***To wind the bobbin***

The Infinity comes with a separate bobbin winder. For full instructions about using the bobbin winder, see the instruction manual that was packaged with the bobbin winder.

📺 **ONLINE:** For more information about using the bobbin winder, watch the video *Using the Bobbin Winder* at: <http://www.handiquilter.com/videos/hq-infinity/245/>.

### ***To insert the bobbin into the bobbin case***

📺 **ONLINE:** For more information about inserting the bobbin into the bobbin case, watch the video *Inserting the Bobbin* at: <http://www.handiquilter.com/videos/hq-infinity/225/>.

⚠️ **CAUTION:** To prevent personal injury always turn off the front power switch while inserting and/or removing bobbin case or anytime your hands are near the needle area, such as when you change the needle.

1. Place the bobbin in the bobbin case so that the thread pulls off clockwise when viewing the open side.
2. Slide the thread through the slot and under the tension spring, leaving approximately five to six inches of thread hanging loose.



### ***To test bobbin tension***

The bobbin tension is the foundation tension for the entire machine. Always set the bobbin tension first.

✎ **NOTE:** Check the bobbin tension each time a new bobbin is inserted.

📺 **ONLINE:** For more information about testing and adjusting the bobbin tension, watch the video *Testing and Adjusting Bobbin Tension* at: <http://www.handiquilter.com/videos/hq-infinity/248/>.

1. With the bobbin properly in the bobbin case, hold the bobbin case in the palm of your hand with the open end facing up.
2. Wrap the thread two to three around the index finger of the opposite hand and lift the bobbin up. The bobbin case should lift up on its side, and slightly lift out of your hand. If the bobbin will not lift up on its side, the bobbin tension is too loose and if it lifts out of your hand, the bobbin tension is too tight.

### **To adjust the bobbin tension**

- Make the adjustment using the screw in the center of the tension spring. Turn clockwise to tighten and counterclockwise to loosen the bobbin case tension. Make tiny adjustments to the bobbin tension and test again.



### **To insert the bobbin case into the machine**

 **ONLINE:** For more information about inserting the bobbin case into the machine, watch the video *Inserting the Bobbin Case* at: <http://www.handiquilter.com/videos/hq-infinity/227/>.

1. Move the needle to the up position. Turn off the front power to the machine.
2. Place the bobbin in the bobbin case so that the thread pulls off clockwise when viewing the open side.
3. Slide the thread through the slot and under the tension spring, leaving 5 to 6 inches of thread hanging loose.
4. To fit the bobbin case onto the hook spindle in the machine, orient the bobbin case as shown in the photo with alignment notch to the right. Push the bobbin case inward until it clicks into place.







 **NOTE:** Do not insert the bobbin case into the machine by lifting the lever on bobbin case. Use the lever only for removing the bobbin case.

## **Easy-Touch Tension™**

One of the joys of quilting with the Infinity is its ability to handle many different types of thread. You can quilt with almost any high-quality thread as long as you first adjust the bobbin tension and then adjust the top tension to suit the thread you've chosen.



Puckering, gathers, and thread breakage occur when the top tension is too tight. Loops and thread nests occur when the top thread tension is too loose. Tension may need to be adjusted depending on the fabric, thread, or batting you are using on the project.

-  **NOTE:** Top tension should be adjusted after the bobbin case foundation tension adjustment is made.
-  **NOTE:** Dark threads will be thicker (because of dye) than light threads of the same weight. The type or brand of thread may also affect tension settings. Each time you change threads, you should check your tension.
-  **ONLINE:** For more information about adjusting the top-thread tension, watch the video *Adjusting the Top-thread Tension* at: <http://www.handquilter.com/videos/hq-infinity/233/>.
-  **IMPORTANT:** Before adjusting your top tension remember to pull the top thread up into the tension discs (flossing the thread) or it will float outside the discs providing little or no top tension. This could cause significant tension or thread nesting problems on the bottom side of the quilt.

The Infinity can also save a top tension setting for up to three types of thread. For more information about setting the top tension presets, see To customize the top tension presets in the Machine Settings section of this manual.

### Machine Quilting Tip: Test the tension settings before quilting

The best way to make sure the top and bottom tension settings are balanced is by quilting. We keep 4-inch squares of light solid fabric on hand to place at the side of the quilt on the extra batting and backing. Then quilt some loops and swirls and look at the stitches on top and underneath to ensure the tension looks good. Fine tune the tension as needed.

-  **NOTE:** The video camera mounted below the quilt is a great way to see the stitching on the back of the quilt and verify that you have good tension settings.

### To adjust the top tension

1. Test stitching with a scrap of fabric placed on the extra batting and backing at the side of the quilt.

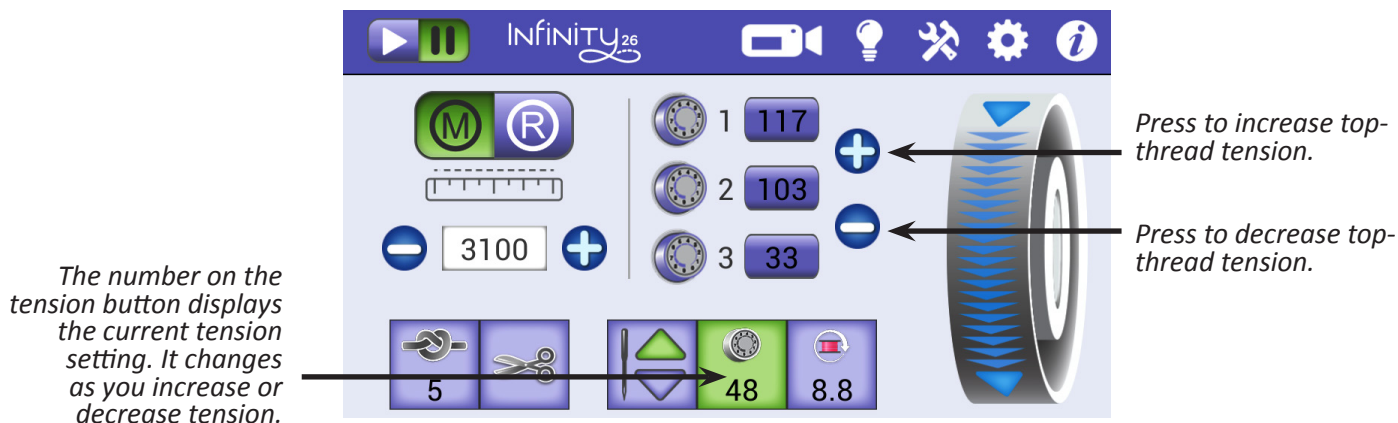

- Adjust the tension by pressing the plus (+) and minus (–) buttons on the Main screen. The tension value appears on the Electronic Tension Button on the Main screen. This value changes as you press the plus (+) and minus (–) buttons.



- Continue to test the stitching on the fabric scrap until you are happy with the tension. If you want to save that setting as one of the tension presets, see *To customize the top tension presets* in the *Machine Settings* section of this manual.

## Tension Quick Start Guide

Bobbin adjustments are minute, like ticks of the clock.

- Always adjust bobbin thread tension first.**

- Stitch out to check top tension.

- If top thread looks like Diagram A

**Problem:** The top thread is too tight.

**Solution:** Press the Easy-Touch Tension button on the Main screen and loosen the top thread tension by pressing the minus button.

- If top thread looks like Diagram B

**Problem:** The top thread is too loose.

**Solution:** Touch the Easy-Touch Tension button on the Main screen and tighten the top thread tension by pressing the plus button.

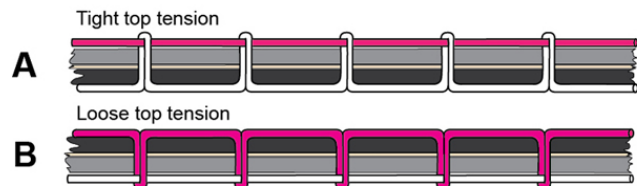
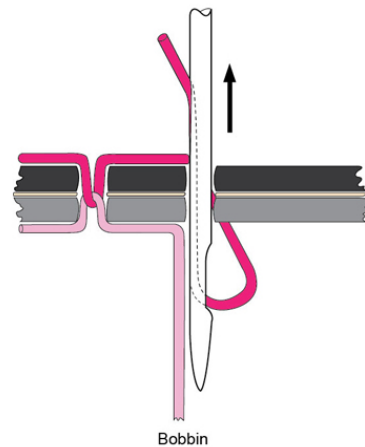

## Threading the Machine

Handi Quilter recommends that you select and use only high-quality threads for your quilts.

### *To thread the machine*

 **ONLINE:** For more information about threading the machine, watch the video *Threading the Machine* at: <http://www.handiquilter.com/dash/videos/video/228/>.

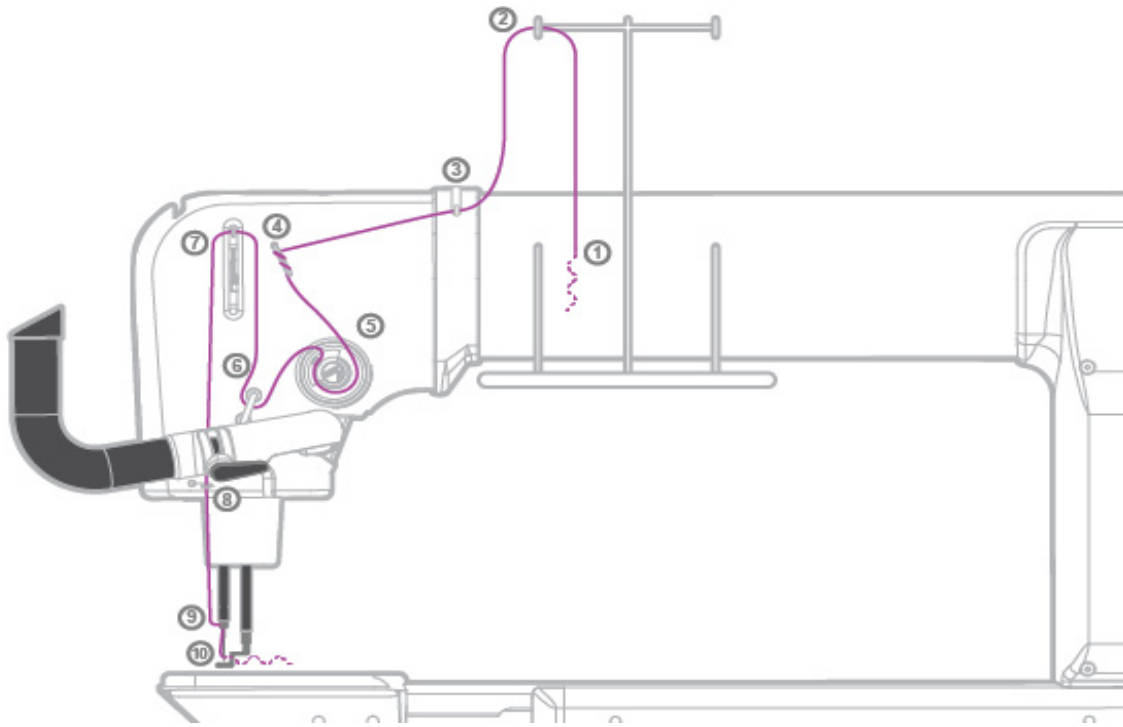

1. Place thread cone onto spool post ① on the thread tray, insert the thread through the thread-mast eyelet ② from back to front, continuing to the thread guide ③.
2. Continue to the three-hole thread guide ④. Wrap all three holes from back to front, being careful not to cross threads. This is recommended for most threads. However, some very delicate threads or metallic threads may require less tension. If you are having problems with thread breaking, try threading only one or two holes of thread guide 4.
3. The thread continues down to the tension assembly ⑤.
  - **IMPORTANT:** The thread must be flossed up between the two tension discs. If the thread is not firmly in place between the two tension discs, the thread will lay on top of the tension discs (no tension) and thread looping on the bottom of the quilt can occur.
4. After the thread is in place, be sure that the thread catches on the take up spring and then pull it down under the stirrup thread guide ⑥.
5. Bring the thread up and through the take-up lever ⑦ from back to front, and then to the pigtail thread guide ⑧, and thread through the needle bar thread guide hole ⑨ .
6. Make sure the thread is following the groove down the front of the needle and insert thread through the eye of the needle ⑩ from front to back. While pulling thread through the eye of the needle be careful that the thread does not twist around the needle.



# Quilting With the Infinity

## Preparing to Quilt

1. Make sure your machine has been cleaned, oiled, has a new needle, and that the tracks on the frame are free from threads or other debris. If the machine isn't already plugged in, plug it in now.
2. Select your thread and wind one or more bobbins.
3. Turn on the main power switch at the back of the machine and then use the front power button on the left side of the machine to turn the machine on or off as needed.
4. Set your bobbin tension and thread your machine.
5. After loading your quilt, use a scrap of fabric along the edge of the quilt backing and batting to test your top tension. Make adjustments to the top tension as needed.

### ***To load the quilt***

 **ONLINE:** To see how to load the quilt onto the frame, watch the video *Loading a quilt* at: <http://www.handiquilter.com/videos/hq-infinity/247/>.

### ***To bring bobbin thread to the top of the quilt***

 **ONLINE:** To see how to bring the bobbin thread to the top of the quilt, watch the video *Starting and Stopping Quilting* at: <http://www.handiquilter.com/videos/hq-infinity/229/>.

1. After the machine is threaded, locate needle up/needle down button on the handlebar. Move the machine over the quilt to your starting location.
2. While firmly holding the tail of the needle thread, press the needle up/down button twice, causing the needle to go down through the quilt sandwich and then back to the up position.
3. Move the machine two to three inches while holding the needle thread in place. The bobbin thread will pull up through to the top of the quilt.
4. Grasp the bobbin thread loop and pull it to the desired length. Reposition the needle to the starting location, tie off the threads by quilting a few stitches in place (or press the Tieoff button on the Main screen), and begin quilting.

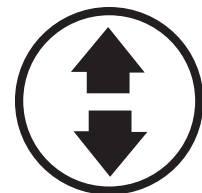

 **NOTE:** If you have customized either the star or diamond button to do a tieoff, press that button on the handlebar instead. For more information about configuring the handlebar buttons, see *To customize the handlebar buttons* in the *Machine Settings* section of this manual.

## To start or stop quilting

- Start or stop the machine at any time by pressing the Start/Pause button on the handlebars.



## To tie off threads when starting and ending quilting

 **ONLINE:** To see how to perform a thread tie off when starting and ending quilting, watch the video *Starting and Stopping Quilting* at: <http://www.handiquilter.com/videos/hq-infinity/229/>.

- Touch the **Tieoff** button on the Main screen to perform a tieoff. For more information about tying off your stitching, see *To configure automatic tieoffs* in the *Toolbar Options* section of this manual.





 **NOTE:** If you have customized either the star or diamond button to do a tieoff, press that button on the handlebar instead. For more information about configuring the handlebar buttons, see *To customize the handlebar buttons* in the *Machine Settings* section of this manual.

## To use the bobbin-thread cutter

The infinity will cut the bobbin thread for you following a tieoff. It cuts the bobbin thread at the needle plate, leaving sufficient bobbin thread for the next time you bring the bobbin thread to the top of the quilt for quilting. You will need to trim the needle thread following a tieoff.

 **ONLINE:** To see how to perform a bobbin-thread cut, watch the video *Using the Bobbin Thread Cutter* at: <http://www.handiquilter.com/videos/hq-infinity/232/>.

- Tie off your quilt stitches and press the bobbin-thread cutter button on the Main screen. If the needle is in the down position, it is raised to the up position before the thread is cut. You'll hear a slight beep to let you know the thread has been cut.
-  **NOTE:** If you configured either the star or diamond button on the handlebars to do a bobbin-thread cut, you can also press that button on the handlebars. For more information about configuring the handlebar buttons, see *To customize the handlebar buttons* in the *Toolbar Options* section of this manual.
-  **NOTE:** If you want a bobbin thread tail that is longer than one inch, move the machine away from your tieoff stitches before pressing the bobbin-thread cut button. The thread tail will match the distance you moved the machine from the tieoff stitches.
-  **NOTE:** You will still need to trim the bobbin thread tails when you remove the quilt from the frame. The length of the thread tail is determined by how far you move your machine between tying off the stitching and doing the bobbin thread cut.

## Free-Motion Quilting

 **ONLINE:** For examples of different types of free-motion quilting, watch the video *Free-Motion Quilting* at: <http://www.handiquilter.com/videos/hq-infinity/246/>.

### Machine Quilting Tip: Relax!

---

When quilting, relax your hands and maintain a light touch on the handlebars. Gripping the handlebars too tightly may cause body tension resulting in poor quilting quality. The Infinity, in combination with the Gallery frame system, will give you a smooth even glide while quilting.

## Micro Quilting

For more information about adjusting the front handlebars for micro quilting, see *To use the handlebars for micro quilting* in the *Installation and Setup* section of this manual.

 **ONLINE:** For more information about micro quilting, watch the video *Micro Quilting* at: <http://www.handiquilter.com/videos/hq-infinity/239/>

## Optional Computer-Guided Quilting: HQ Pro-Stitcher®

The HQ Pro-Stitcher® quilting system integrates Handi Quilter's quilting machines, including the Infinity, with the best computer technology for computer-guided quilting using digital designs. The software is managed from a state-of-the-art tablet computer that is conveniently mounted on top of the machine. This rich and full-featured software is easy to learn and makes precise quilting simple and fun!

### Using the HQ Pro-Stitcher Tablet on Your Infinity

When you add HQ Pro-Stitcher to your Infinity, the HQ Pro-Stitcher tablet computer replaces the front touch-screen display. The Infinity software functions the same when used on the tablet computer. However, when also using HQ Pro-Stitcher, the Pro-Stitcher software sometimes overrides some of the Infinity settings. For more information about how HQ Pro-Stitcher works with the Infinity, see the HQ Pro-Stitcher user manual.

 **ONLINE:** For more information about installing the HQ Pro-Stitcher tablet computer on the Infinity, refer to the HQ Pro-Stitcher user manual for the Infinity or watch the video *Using the HQ Pro-Stitcher Tablet Computer With the Infinity* at: <http://www.handiquilter.com/videos/hq-infinity/230/>.

First turn on the Infinity; then turn on the HQ Pro-Stitcher tablet computer. Both HQ Pro-Stitcher software and the Infinity application console start up.

 **NOTE:** After the Infinity application console starts, it works the same as if you were running it from the smaller touch-screen display, as described in the *Using the Touch-Screen Displays* and *Toolbar Options* sections of the manual.

While the Infinity and HQ Pro-Stitcher are running, a menu appears in the upper left corner of the screen. Touch a button on this menu to switch between using HQ Pro-Stitcher, using the Infinity console, and using Art & Stitch. You can also open the onscreen keyboard, switch to the video camera, or close the menu from view.

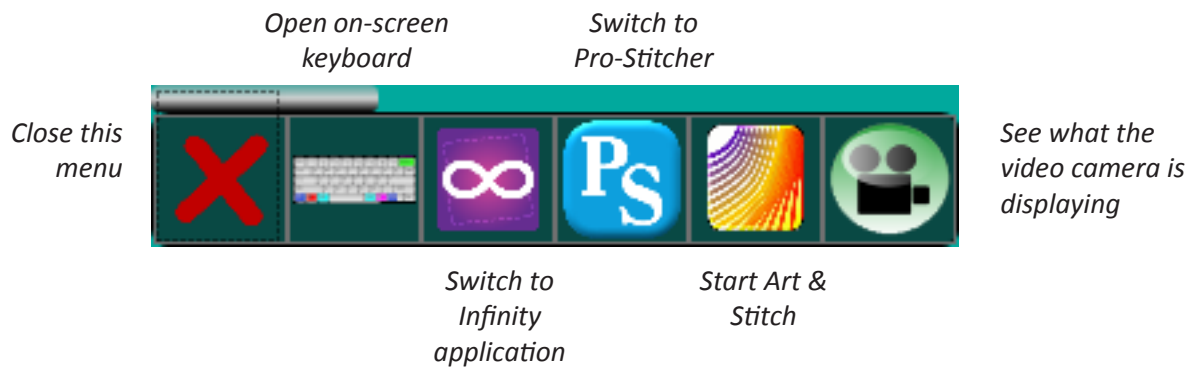

Use HQ Pro-Stitcher to quilt, or switch to free-motion quilting by disengaging the HQ Pro-Stitcher motors. (In HQ Pro-Stitcher, select **Design**, then **Freehand**. Then select the **Free Motion** button.)

## Handlebar Star and Diamond Buttons with Pro-Stitcher

Four functions in HQ Pro-Stitcher override your custom settings for the star and diamond buttons on the handlebars: when creating 2-point (star button) and multi-point areas (diamond button), when starting and stopping freehand recording (star button), and when marking lines for quilting (diamond button). See the Infinity version of the HQ Pro-Stitcher manual for more information about how the star and diamond buttons work with these functions.

## Updating the Infinity Software

If you are running the Infinity from a Pro-Stitcher tablet computer, the Update screen has only the machine icon. You will update the Infinity machine software and the rear display using the Update option on the Tools menu. However, the Infinity application console software is part of the Infinity version of the Pro-Stitcher software. Make sure you are also using the latest version of the Pro-Stitcher software.

# Using the Touch-Screen Displays

The Infinity has touch-screen displays on the front and rear handlebars. They each work the same. For example, use the displays to alternate between stitch-regulated and non-stitch regulated operation, to control settings for how you prefer your machine to operate, and to use tools such as counting stitches on a quilt or logging how much time it took to finish your quilt.

 **ONLINE:** For information about using the touch-screen displays, watch the video *Using the Touch-Screen Displays* at: <http://www.handiquilter.com/videos/hq-infinity/231/>.

 **NOTE:** If you have HQ Pro-Stitcher®, you should have installed the tablet computer that came with HQ Pro-Stitcher at the front of the machine rather than the 7-inch touch screen. You will then use the HQ Pro-Stitcher tablet to control the functions of the Infinity.

Buttons are selected, or on, when they are green and display black text or graphics. Buttons are off when they are purple and display white or lighter gray text or graphics. When you touch a button, it will toggle on or off, open a pop-up box for you to enter information, or open a screen with more options.



If a button cannot be used, usually because another process is underway, it will be gray.

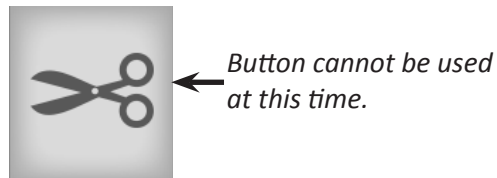

# Overview of the Main Screen

The Infinity Main screen provides quick access to all functions.

These buttons indicate whether or not your machine is stitching or paused. It is currently paused because the pause button is green, or on.



This toolbar appears on every screen to provide quick access to often-used options. When selected, the icons will be green, not white.



Touch this icon for the view from the Quilt View™ video camera. For more information about the camera options, see *Using the Video Camera* in the *Toolbar* section of this manual. For information about installing the video camera, see *To install the video camera* in the *Installation and Setup* section of this manual.



Touch this icon to open the Lights screen. For more information about turning lights on and off, see *Controlling the lights* in the *Toolbar Options* section of this manual.



Touch this icon to open the Tools. For more information about the various tools, see *Machine Tools* in the *Toolbar Options* section of this manual.



Touch this icon to open the Settings. For more information about the various settings, see *Machine Settings* in the *Toolbar Options* section of this manual.



Touch this icon to see system information, as well as a machine threading guide and needle/thread guide. For more information about the system information that is available, see *Information Screens* in the *Toolbar Options* section of this manual.

This area of the Main screen controls the stitching modes. It is currently set to manual mode and shows the current stitches per minute setting and three stitches-per-minute presets. This area changes according to the stitching mode you've selected.



The on-screen hand wheel enables you to rotate the machine's hand wheel from the Main screen rather than reaching around the machine to do it manually.

These buttons remain the same regardless of the stitching mode you choose.



**Tie-off button:** Use this button to perform a tieoff at the start or finish of your stitching. Touch the button and gently move the machine to perform the micro stitches. The number below the image indicates how many micro stitches will be performed.

For more information about how to configure the number of micro stitches in a tieoff, see *To configure tieoffs* in the *Toolbar Options* section of this manual.



**Bobbin-thread cutter button:** Touch this button to perform a bobbin thread cut. The Infinity cuts the thread at the needle opening in the needle plate, leaving enough bobbin thread for your next pullup.

 **ONLINE:** For information about using the Bobbin-thread cut button, watch the video *Using the Bobbin-Thread Cutter* at: <http://www.handiquilter.com/videos/hq-infinity/232/>.

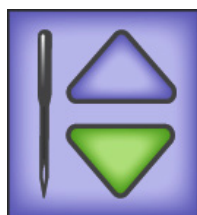

**Needle-stop button:** Touch the button to alternate between having the needle stop in the up or down position when you stop stitching. Your choice displays in green (as shown at the left).

This button does not move the needle, but rather indicates your preference for the final needle position when quilting is stopped.

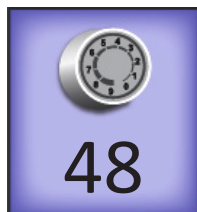

**Easy-Touch Tension™ button:** Touch this button and then use the plus (+) and minus (-) buttons on the screen or on the handlebars to increase or decrease the upper tension. The number on the button indicates the current tension setting.

For more information about electronic tension, see *Top Thread Tension* in the *Machine Settings* section of this manual.

 **ONLINE:** For information about setting the top-thread tension, watch the video *Adjusting the top-thread tension* at: <http://www.handiquilter.com/videos/hq-infinity/233/>.





**Reset-bobbin button:** Press this button after a bobbin change if you are using the low-bobbin alarm. This resets the low-bobbin reading to indicate you are using a full bobbin. The number on this button shows an estimate of how much thread remains on the bobbin. This number updates as you quilt. As the number gets closer to zero, the bobbin is running out of thread. For more information about the low-bobbin settings, see *To add a new bobbin configuration and record bobbin capacity* in the *Toolbar Options* section of this manual.

- **IMPORTANT:** Touch this button only to reset the bobbin capacity to indicate a full bobbin. If you want to open the Low Bobbin Alarm screen, select the **Machine Settings** toolbar button and then select the **Low Bobbin Alarm** screen.

### *To use the on-screen hand wheel*



The on-screen hand wheel enables you to rotate the hand wheel from the Main screen rather than reaching around the machine to do it manually.

Drag your finger down from the top of the onscreen hand wheel (in the direction of the arrows) to cycle the needle bar and the presser bar.

- ✎ **NOTE:** You can, if necessary, move your finger in an upward motion to turn the hand wheel in the opposite direction. You'll typically do this only when you need to break a thread lock.

## Stitching Modes

The Infinity enables you to choose between two modes of stitch regulation (Cruise or Precision) or to choose manual stitching. It also includes a basting mode.

### Manual Stitching Mode

When using the manual stitching mode, the length of the stitch is determined by how quickly or slowly you move the machine around the quilt, in combination with the number of stitches per minute (up to 3100) you have selected. For a consistent stitch length, you will need to move the machine at a consistent speed. Experiment with different combinations of quilting speed and stitches per minute to find what optimally works for you.

### *To use manual stitching mode*

- 📺 **ONLINE:** For information about using manual stitching mode, watch the video *Using Manual Stitching Mode* at: <http://www.handquilter.com/videos/hq-infinity/234/>.



- Touch the **Manual** button and then specify the stitches per minute (SPM) by pressing the plus (+) or minus (–) buttons on the screen or selecting one of the stitches-per-minute presets. Pressing the plus (+) or minus (–) buttons on the screen to change the stitches per minute has the same effect as pressing the plus (+) or minus (–) buttons on the handlebars.

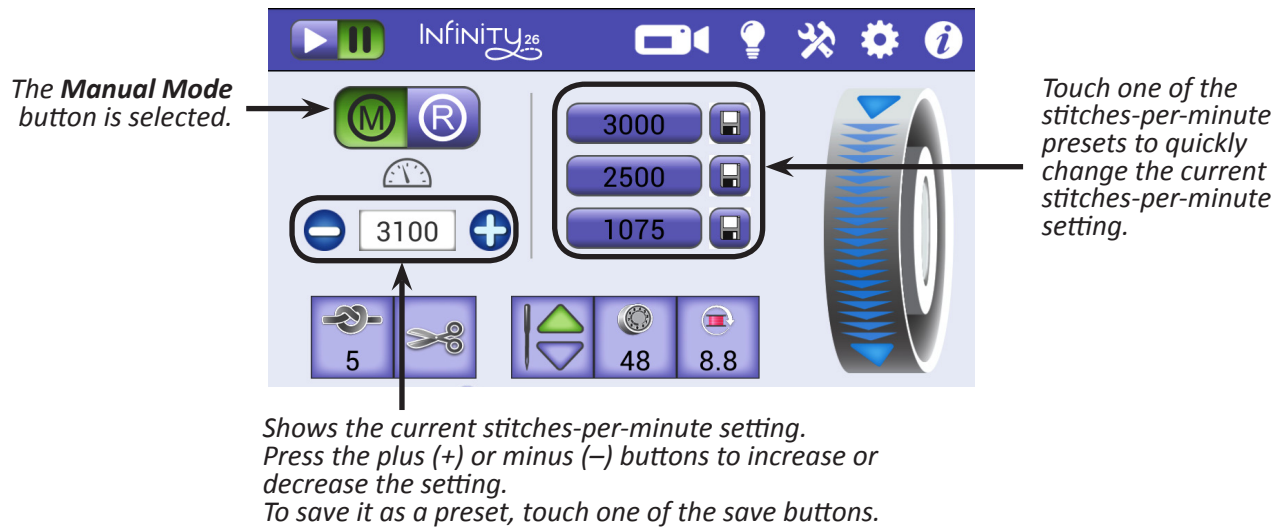

### To configure the manual stitching mode preset speeds

The manual mode preset speeds are three stitches-per-minute speeds, up to 3100 stitches per minute (SPM), that are saved for quick access from the Main screen. After you set the speeds, you can choose one of the presets when in Manual stitching mode and it becomes the current speed. Perhaps you want one speed when doing overall quilting, a different speed for ruler work, and yet another speed for micro quilting.



1. Select Manual stitching mode by touching the **Manual** button.
2. Press the plus (+) button to increase or the minus (–) button to decrease the current stitches per minute setting.
3. Touch the save button next to one of the stitches per minute presets to save the current setting as a preset.

## Machine Quilting Tip: Getting started with Manual mode

---

Set the machine at a medium speed (such as 1000) and begin moving it until you become accustomed to the resistance. By moving the machine faster, the stitches will begin to elongate. The stitch speed can either be increased or the machine can be moved slower to get the stitches at your desired length. By moving the machine slower, the stitches get shorter and can build up on top of each other, break the thread, or make it extremely difficult to unpick. The stitching speed can be decreased, while maintaining a constant motion with the machine to bring the stitches to the desired length.

## Stitch Regulation

There are two stitch regulation modes: Cruise and Precision.

### To use Cruise stitch regulation

📺 **ONLINE:** For information about using Cruise stitch regulation, watch the video *Using Cruise Stitch Regulation* at: <http://www.handiquilter.com/videos/hq-infinity/235/>.

- Touch the **Regulated** button and then touch the **Cruise** button.

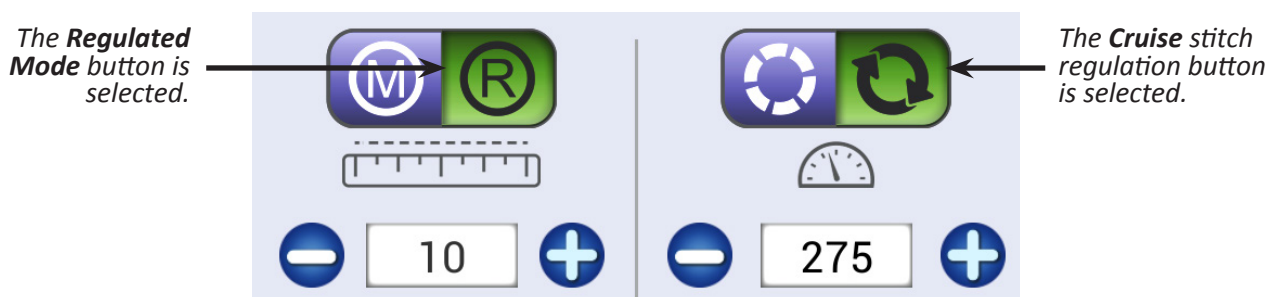

*Shows the current stitches-per-inch setting. Press the plus (+) or minus (-) buttons onscreen or on the handlebars to increase or decrease the setting.* *Shows the current stitches-per-minute setting. Press the plus (+) or minus (-) buttons onscreen to increase or decrease the setting.*

After you press the Start/Pause button on the handlebars, the machine immediately begins quilting according to the stitches-per-minute and stitches-per-inch settings. The Start stitching indicator in the upper-left corner of the screen turns green and the needle begins moving up and down. Similarly, as you bring your quilting to a stop, the needle will continue stitching at the cruise speed (stitches per minute) until you press the stop button on the handlebars. The minimum speed of the needle is dependent upon the stitches-per-minute setting you choose. Handi Quilter recommends beginning with a setting of 200. Begin moving the machine to avoid stitching in place for too long.

## Machine Quilting Tip: When to use Cruise stitch regulation

---

The constant minimum stitching speed featured in the Cruise stitch regulation is useful for precise placement of stitching, such as when backtracking along the tops of feathers or when creating sharp points such as the point of a star or the bottom of a heart.

## To use Precision stitch regulation

 **ONLINE:** For information about using Precision stitch regulation, watch the video *Using Precision Stitch Regulation* at: <http://www.handiquilter.com/videos/hq-infinity/236/>.

- Touch the **Regulated** button and then press the **Precision** button.



*Shows the current stitches-per-inch setting. Press the plus (+) or minus (-) buttons onscreen or on the handlebars to increase or decrease the setting.*

After you press the Start/Pause button on the handle bars, you must begin moving the machine for it to begin quilting according to the stitches-per-unit of measure setting. The Start stitching indicator in the upper-left corner of the screen turns green but the needle doesn't automatically begin moving up and down. When you begin moving the machine, stitching begins. When you stop moving the machine, stitching stops but just until you move it again.

 **NOTE:** When using Precision stitch regulation, if you stop moving the machine but do not press the Stop/Pause button, after two minutes it will time out and a message box appears to let you know you will need to press the Start/Pause button to resume quilting.

 **CAUTION:** Always make sure the power is off when changing the needle, replacing the bobbin, or placing your hands near the needle to avoid unwanted stitching in your quilt or in your fingers.

### Machine Quilting Tip: When to use Precision stitch regulation

---

Precision stitch regulation mode is useful for ruler work. Stitch along the length of the ruler for the span of your hand and stop moving the machine, but do not press the Stop button. When you stop moving the machine, the needle pauses. Move the ruler and then begin moving the machine to continue quilting. Precision stitch regulation helps you to avoid bobbles and uneven stitches.

### Machine Quilting Tip: Getting started with stitch regulation

---

Set the machine to your desired stitch length. Begin moving the machine to become accustomed to the resistance. The machine motor will slow down or speed up to maintain a consistent stitch length according to how quickly or slowly you move the machine. Moving the machine too fast or in radical or jerky movements will defeat the stitch regulator function.

### Machine Quilting Tip: Quilting speed while in stitch-regulation mode

---

It is unlikely that you will move the Infinity across the quilt too fast. However, if you do, it will result in an overspeed condition if the machine can't maintain stitch regulation. An overspeed alarm, if turned on, will alert you that you should slow down your quilting to maintain stitch regulation.

## Basting Mode

The Infinity includes five basting stitch options for basting a quilt. The basting stitch options are available in stitch regulation mode only.

The stitches-per-inch setting ranges between 5 stitches per inch and 24 stitches per inch. If you continue to press the minus (–) button on the screen, after 5 you will see B1/4", B1/2", B1", B2", and B4".

B1/4"	One stitch every quarter inch of movement of the machine
B1/2"	One stitch every half inch of movement of the machine
B1"	One stitch every one inch of movement of the machine
B2"	One stitch every two inches of movement of the machine
B3"	One stitch every four inches of movement of the machine

 **ONLINE:** For information about basting mode, watch the video *Basting a Quilt* at: <http://www.handquilter.com/dash/videos/video/237/>.

### *To baste a quilt*

1. Touch the **Regulated** button.
2. Press the minus (–) button next to the stitches-per-inch box on the screen until you see 5 stitches per inch. Continue touching the minus (–) button and the four basting stitch options appear. Choose the one you want to use – either B1/4", B1/2", B1", B2", or B4".
3. Begin basting the quilt by pressing the Start button. As you move the machine across the quilt, it will perform a stitch (needle down and then needle up) every one quarter, one half, one, two, or four inches according to your choice of basting stitch length.

### Machine Quilting Tip: Basting the edges of the quilt

---

If you are basting the edges of the quilt to the batting and backing, choose a low number of stitches per inch, somewhere between 5 to 8 stitches per inch, rather than one of the basting-mode stitches. This will help to prevent the hopping foot from going between the batting and quilt top.

# Toolbar Options

The toolbar is in the upper-right corner of the screen at all times.

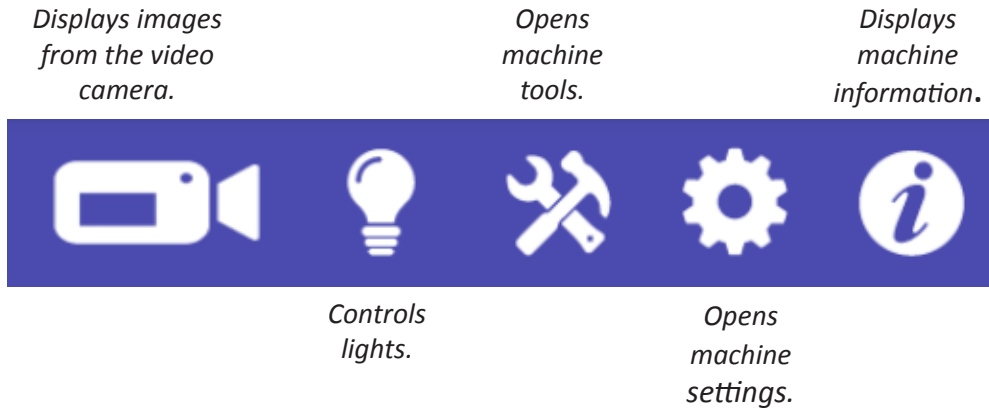

## Using the Quilt-View™ Video Camera

When you touch the video icon, you will have the option to turn off all of the machine lights by touching the light bulb icon at the right of the screen. This often results in clearer images from the video camera under the quilt. When you quilt using the video camera, the lights return to their previous setting.

As you move the machine across the quilt, the view of the quilt from the video camera appears on the touch-screen display.

Manually rotate the knob on the camera lens to adjust the focus as needed. You can also use the dial built into the camera's cable to dim or brighten the camera's LED lights to improve visibility.

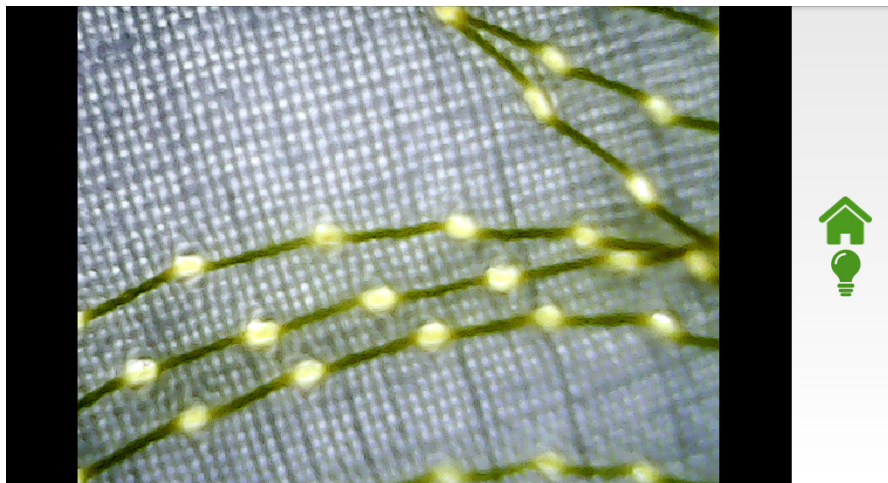

## Controlling the Lights

Your Infinity comes equipped with three standard lights plus UV lights. You cannot use both the standard lights and the UV lights at the same time.

 **ONLINE:** For more information about controlling the lights, watch the video *Controlling the Lights on the Infinity* at: <http://www.handiquilter.com/videos/hq-infinity/242/>.

## To control the lights on the machine

- To open the Lights screen, touch the **Lights** icon in the toolbar. After selecting the icon, it turns green and Lights screen opens.

Light 1 is under the arm of the machine. Light 2 is the light ring that illuminates the needle and stitching area. Light 3 is on the handlebars and adds light to the stitching area.

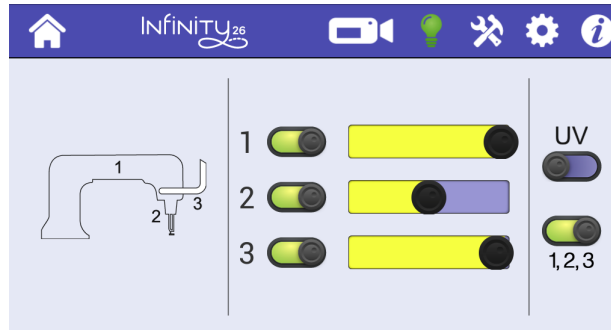

The **Lights** button is selected (green).

Touch the UV light button to turn it on or off. When you turn the UV lights on, all other lights are turned off.



When lights are on, the on/off button displays in color. Touch the on/off button to quickly turn off the light.



Touch the All Lights (1,2,3) button to turn on all of the lights at once. If they are already on, touch the button to turn off all lights at once.



Otherwise, use the slider to vary the intensity of the light. Touch the black dot and drag to the right to increase the intensity or to the left to decrease the intensity. The intensity settings are saved when lights are turned off and will be the same when you turn them on again.

## To use UV lighting

UV lighting can be very useful when viewing white thread or white chalk on white fabric. The best contrast is achieved when viewed in a dark or dimly lit room. Although Handi Quilter has chosen to use UV lights which emit a light wavelength at the lowest end of the UV spectrum to minimize eye strain and damage, constant or direct exposure to any UV lighting can cause eye strain and may lead to permanent eye damage. Be careful and avoid looking directly at the UV lights (which emit a violet colored light). The UV lights should only be used when other lighting sources cannot produce the visual contrast necessary to achieve accurate quilting.





- Touch the **UV** light button to turn on or off the UV lights. When you turn the UV lights on, all other lights are turned off. When you turn off the UV lights, the standard lights turn on again.

- △ **CAUTION:** Looking directly into the UV lights or prolonged exposure to the UV lights can damage your eyes. Limit the use of the UV lights to avoid permanent eye damage. Using UV A/B blocking sunglasses will reduce eye strain and limit the effects of prolonged exposure to UV lighting.
- △ **CAUTION:** Users who have had cataract surgery should not use the UV lighting unless they have had UV A/B blocking replacement lenses implanted as part of the surgery.

## Machine Tools

To open the machine tools, touch the Tools icon in the toolbar. After selecting it, the icon turns green.



The **Tools** button is selected (green).

Choose from the five tools at the bottom of the screen.

*Sets the quilting timer, the quilting alarm, and the stitch counter.*

*Opens the on-screen calculator.*

*Updates the machine's software.*

*Calibrates the Easy-Touch Tension™.*

*Opens the Diagnostics screen.*



After you select an option, the button background turns to green and the screen changes for you to do any customization of that setting. The next time you touch the Tools icon, the last Tools option you used appears.

### Quilting Timer, Alarm, and Stitch Counter

The timers screen enables you to track the amount of time you work on a quilt, to set a timer to remind you when your quilting time is up, and to track the number of stitches on a quilt.

🔗 **ONLINE:** For more information about the quilting timer, quilting alarm, and stitch counter, watch the video *Setting and Using the Quilting Alarms and Stitch Counter* at: <http://www.handiquilter.com/videos/hq-infinity/241/>.

- Touch the **Tools** icon in the toolbar. Then touch the **Timers** button. Press the **Home** button to return to the Main screen.



### To track how much time you spend on a quilt

Use the quilting timer to keep track of how much time you spend on a quilt. The quilting timer measures time the machine is actually quilting, not the time the machine is on but idle.

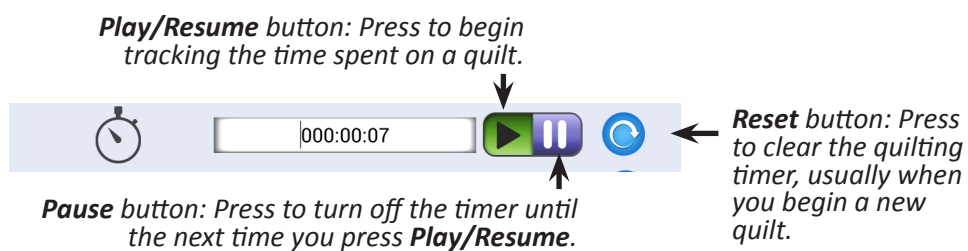

1. When you begin a new quilt, press **Reset**.
2. When you are ready to begin tracking the time spent on a quilt, press **Play**. Proceed with your quilting. When you are through quilting for a time, press **Pause**.
3. When you resume quilting, press **Play** again. The quilting timer will continue tracking your time and add it to the previously recorded time.

### To track the number of stitches in a quilt

Use the stitch counter to count the number of stitches in a quilt.

- Press the **Reset** button to zero-out the counter when you begin a new quilt. To see the lifetime stitch counter for your machine, see the *Information* screen.



## To set the quilting alarm

Use the quilting alarm to set a reminder that alerts you when the time you've allotted for quilting is done. After you enable the alarm, the time begins to count down. Unlike the quilting alarm, this alarm measures elapsed time, not machine quilting time. The example below shows only 3 minutes and 55 seconds are remaining before the alarm will sound.

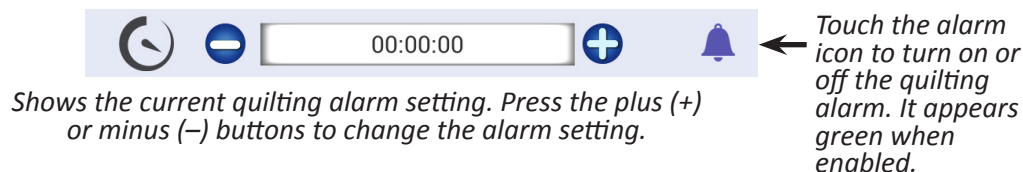

1. Specify the amount of time that will elapse before the alarm will go off. Fine tune the alarm setting by pressing the plus (+) or minus (-) buttons which changes the alarm setting by one minute at a time.
2. Touch the alarm icon to turn on the quilting alarm. When the time has elapsed, an alarm will sound.

## On-screen Calculator

The Infinity includes a basic on-screen calculator. It functions like all basic calculators. For example, press a number button and a function button followed by another number button. Function buttons include addition (+), subtraction (-), multiplication (x) and division (÷). After you've pressed the numbers and the function buttons, press the equal sign (=) for the answer.

- Touch the **Tools** button in the toolbar. Then touch the **Calculator** button along the bottom of the screen. Press the **Home** button to return to the Main screen.



## Software Updates

From time to time Handi Quilter releases software updates for their machines. This update feature enables you to take advantage of the latest new capabilities added to machines. When an update is released, download the updated file(s) to a USB drive using a computer that is connected to the Internet.

- Touch the **Tools** button in the toolbar. Then touch the **Update** button along the bottom of the screen. Press the **Home** button to return to the Main screen.



- After downloading the updated software to a USB drive, insert the drive in the designated USB port in the machine. Look for the message in the bottom bar that confirms a USB drive has been inserted. If it doesn't appear, reinsert the USB drive. Then touch the **Update** button.



### To update the machine's software

- 🔊 **ONLINE:** For more information about updating the machine's software, watch the video *Updating the Software on the Infinity* at: <http://www.handiquilter.com/videos/hq-infinity/243/>.
- 🔔 **IMPORTANT:** If you are running the Infinity from a Pro-Stitcher tablet computer, the Update screen has only the machine icon because you update the machine software only. The Infinity software is part of the Pro-Stitcher software. Make sure you are also using the latest version of Pro-Stitcher. However, you'll update the rear display using the instructions below.

1. Insert the USB drive into the first USB port on the front-left side of the machine. Then touch the machine icon to update the machine's software.



2. You will be prompted to choose the file you want to use to update the machine software. Touch the **Select Version** box and then select the filename of the update file you downloaded.

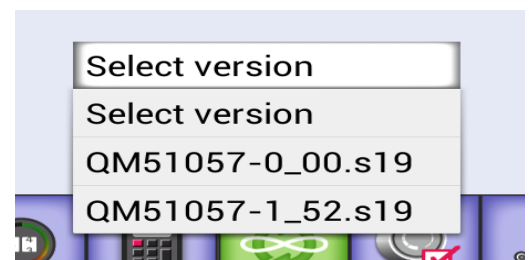

3. Be patient as this will take a few minutes.

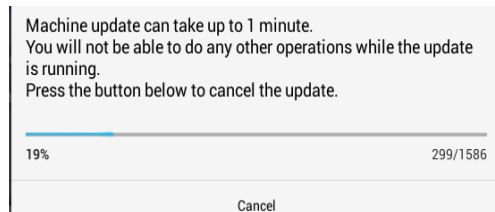

4. When done, the lights will flash and the HQ Infinity will reboot.

### To update the display software

You will need to update the display on both the front and rear handlebars.

1. After inserting the USB drive into the first USB port on the front-left side of the machine, touch the display icon to update the display's software.

**NOTE:** To update the rear display, you must first unplug the USB cable from the bottom of the display and insert the USB drive with the software. After updating, replace the USB drive with the display's USB cable.

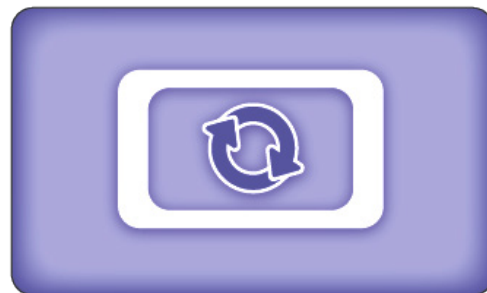

2. You will be prompted to choose the file you want to use to update the display software. Touch the **Select Version** box and then select the filename of the update file you downloaded.

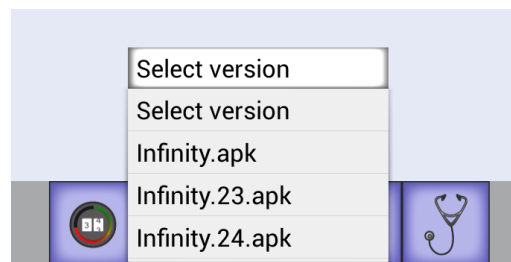

3. When the message box appears, select **New** and **Install**.

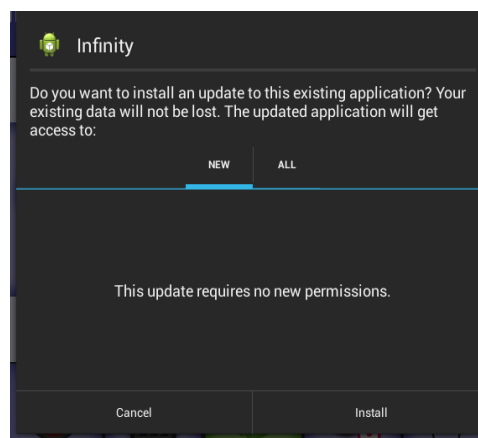

4. Be patient as this will take a few minutes.

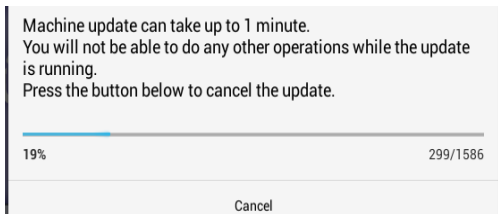

5. Confirm that you want to overwrite the current software with the new software by choosing **Install**. If you decide to not update the software, choose **Cancel**.

## Calibrate Tension

If you experience any difficulty adjusting the Easy-Touch Tension™, you may need to calibrate the tensioner. Typically you will only do this when instructed by Handi Quilter technical support.

Touch the **Tools** button in the toolbar. Then touch the **Calibrate Tension** button along the bottom of the screen. Then touch the tension button in the center of the screen. Press the **Home** button to return to the Main screen.



It takes approximately thirty seconds to complete the calibration. You may see the movement of the tensioner as it is calibrating. The machine will beep when the calibration begins, when it is halfway through the calibration, and will emit a slightly longer beep when calibration completes.

When you check the tension setting after calibration, it will be set to 112, the midpoint for tension. Before quilting, select one of your tension presets (see *To customize the top-thread tension presets* in the *Machine Settings* section of this manual) or adjust top tension as described under *Easy-Touch Tension™ Presets* in the *Using Your Machine* section of this manual.

## Diagnostics

There are several diagnostics tests that you may be asked to perform by Handi Quilter technical support or authorized Handi Quilter representatives. They will give you a code to enter into the Diagnostics screen to be able to perform the tests.

- Touch the **Tools** button in the toolbar. Then touch the **Diagnostics** button along the bottom of the screen. Enter the code you receive from Handi Quilter technical support, and follow their



instructions for the different diagnostics tests.

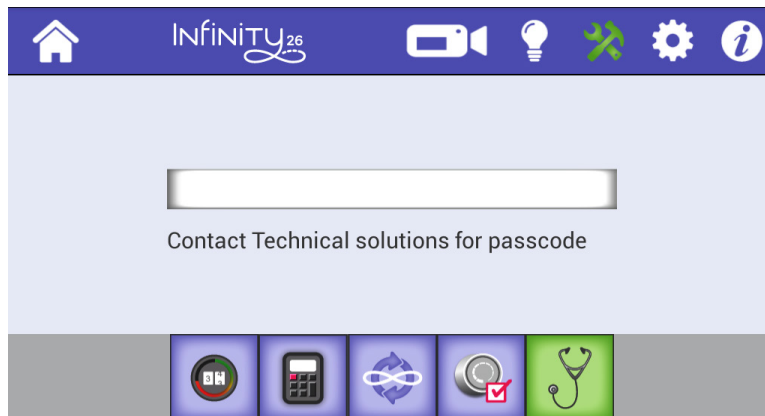

Contact your local representative or Handi Quilter technical support at +1 (801) 292-7988 or 1-877-MY-QUILT (697-8458).

## Machine Settings

To open the machine settings, touch the **Settings** icon in the toolbar. After selecting it, the icon turns green.



Then choose one of the seven options that appear along the bottom of the screen (shown below). After you select an option, the button background turns to green and the screen changes for you to do the configuration of that setting. The next time you touch the Settings icon, the last Settings option you used appears.

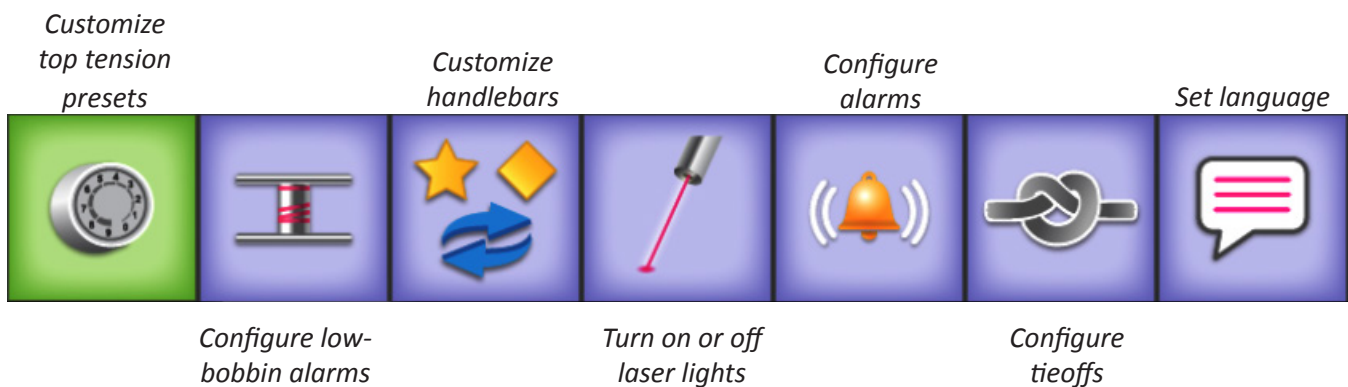

- Press the **Home** icon in the upper left corner of the screen to close **Settings** and return to the Main screen.

## Easy-Touch Tension™ presets

You can configure top-thread tension presets for three types of thread. For example, one setting might be for a 50-weight thread, one for a 30-weight thread, and one for monofilament thread. After you establish the tension presets, select the tension setting to use on the Main screen as shown below.

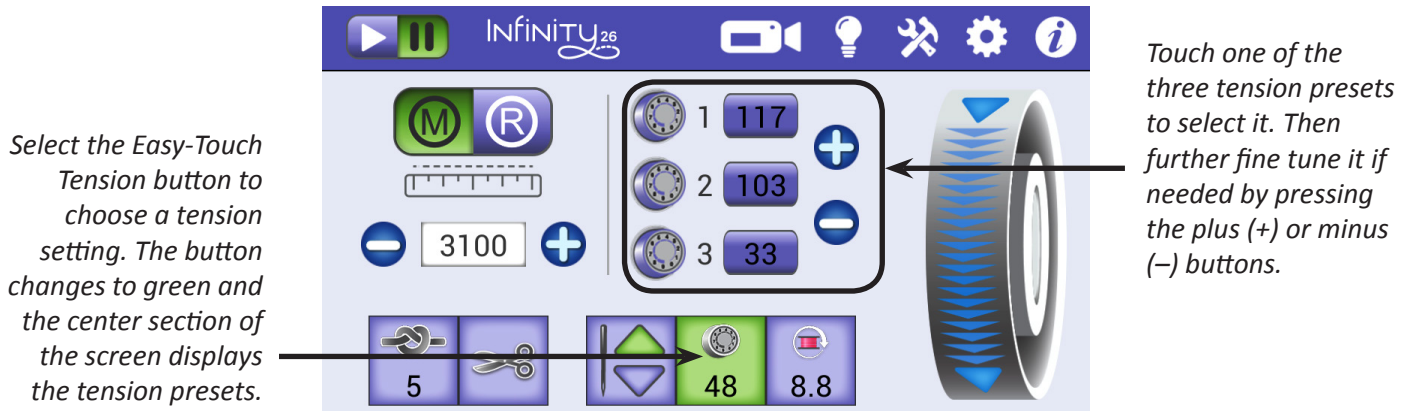

### To customize the Easy-Touch Tension™ presets

As described in *Bobbin and Bobbin Tension* in the *Using Your Machine* section of this manual, make sure your bobbin tension is properly set before adjusting the top tension.

Thread the machine with the thread for which you want to define a top-thread tension preset. Follow the steps for setting the top-thread tension (see *Easy-Touch Tension™* in the *Using Your Machine* section of this manual). When you are happy with the stitching, note the tension value on the Electronic Tension Button and follow the steps below to save it as a preset.

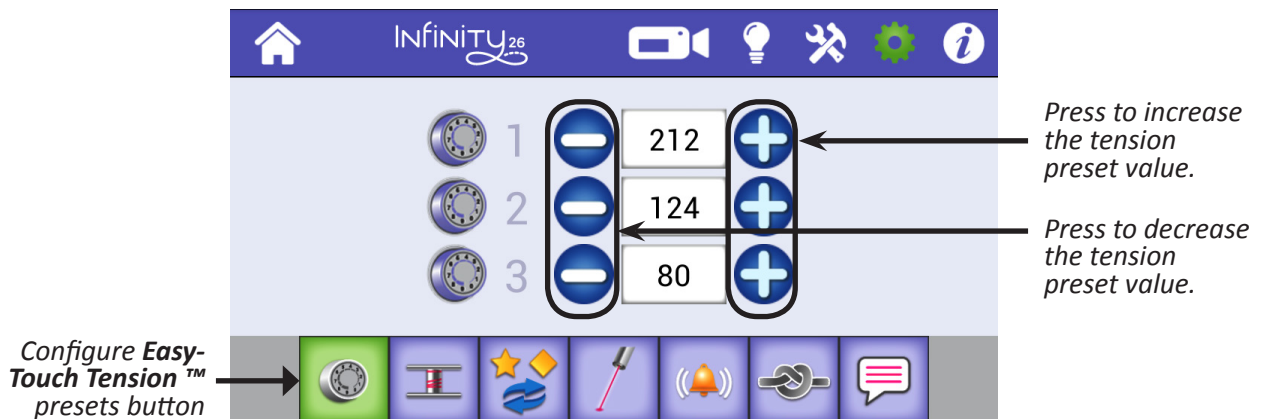

1. Touch the **Settings** icon in the toolbar. Then touch the **Configure Tension Presets** button to open the Tension Presets screen.
2. Press the plus (+) or minus (-) buttons to increase or decrease the settings for one of the three settings until it matches the tension value you want to use. (You should have already tested the tension to

determine the correct value for that type of thread.) Then press Home to return to the Main screen.

**NOTE:** You can also touch the number box for the setting and directly enter the number using the pop-up number pad. Then press **Done** to close.

- On the Main screen, touch the **Easy-Touch™ Tension** button and then select the preset you want to use. Further fine tune the tension using the plus (+) or minus (-) buttons on the screen.

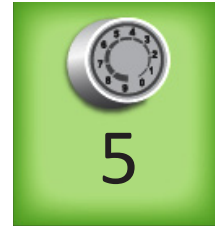

**NOTE:** After you select a tension preset, you can also use the plus (+) or minus (-) buttons on the handlebars to adjust the tension. Each press on the handlebar buttons changes the tension value by two, whereas each press of the onscreen plus (+) or minus (-) buttons changes the tension value by one. You will not be able to use the handlebar buttons to adjust speed or stitch length while the Easy-Touch Tension button is selected, or while setting tension presets.

## Low-Bobbin Alarm

The amount of thread that fits on a bobbin varies according to the type and weight of thread you use. You can create a low-bobbin threshold for up to twenty types of thread that you use in your bobbin. You'll then use this threshold for setting a low-bobbin alarm to alert you to when the bobbin thread is running out.

**ONLINE:** For more information about the low-bobbin alarm and customizing the low-bobbin presets, watch the video *Using the Low-Bobbin Alarm* at: <http://www.handiquilter.com/videos/hq-infinity/240/>.

- Touch the **Settings** icon in the toolbar. Then touch the **Low-bobbin Alarm** button.

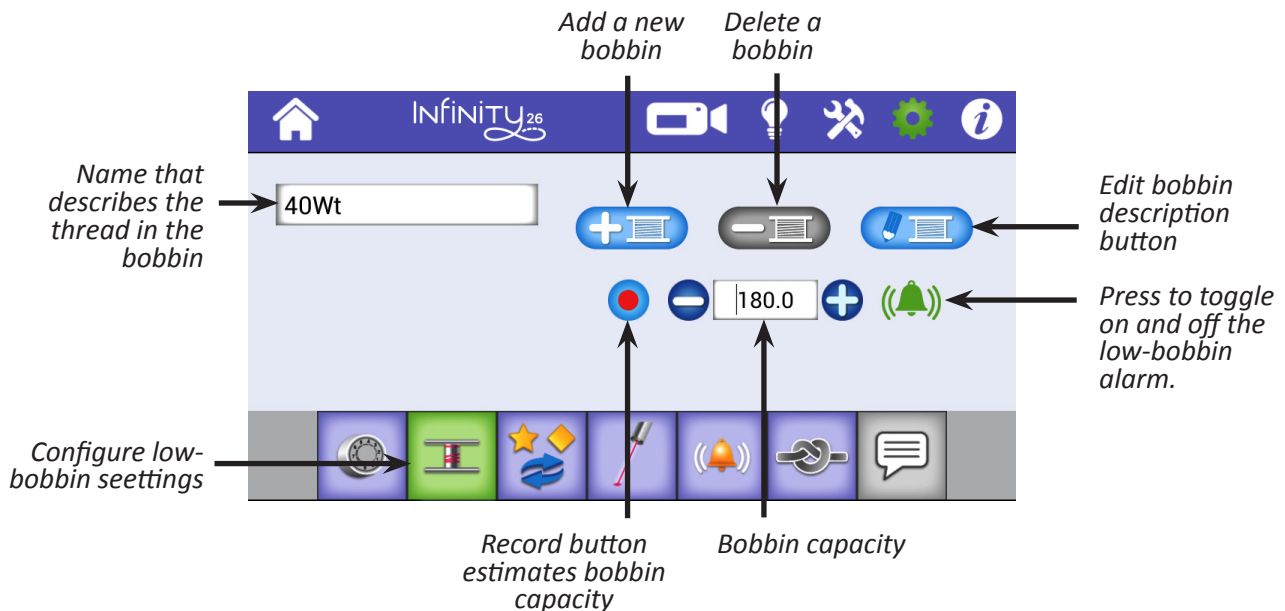

### To add new bobbin configuration and record bobbin capacity

1. When you are ready to define a new bobbin capacity for a particular type of thread, completely fill a bobbin with that thread and insert it into the machine.

2. Touch the icon to add a new bobbin. Use the pop-up keyboard to enter a descriptive name so you will know which type of thread this configuration applies to. Close the pop-up keyboard by touching arrow in the lower-left corner of the screen.



3. Touch the Record button. The bobbin capacity value will reset to zero. Quilt until the bobbin runs out.

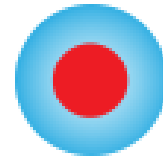

 **NOTE:** The Reset Bobbin button on the Main Screen shows the bobbin capacity as you quilt. When you touch the Reset Bobbin button, it shows the estimated capacity of the full bobbin. As you quilt, this number counts down. While you are recording the bobbin capacity of a bobbin, the number increases as you quilt until it runs out of thread.

4. Return to the low-bobbin alarm screen and press the Record button again to stop recording. The number that appears in the Bobbin Capacity box is an estimate how much thread is on the bobbin.



5. Estimate how much bobbin thread you think you'll use for tieoffs and decrease the bobbin capacity by that much. Press the minus (–) button to decrease the capacity. Or, touch the Bobbin Capacity box to pop up an onscreen number pad and enter the number directly.



6. When you are ready to use a full bobbin with that type of thread, insert the full bobbin and press the Reset Bobbin button on the Main screen



7. Make sure the alarm icon is enabled (green), or on. If not, touch the alarm icon to toggle it on. When the bobbin level reaches zero, the low-bobbin alarm will sound if it is turned on.



 **NOTE:** If you turn on or off the low-bobbin alarm on this screen, it is also turned on or off on the Alarms screen.

The next time you use one of the threads for which you've set up a low-bobbin threshold, touch the bobbin name box and choose the specified thread name by touching it. Insert a full bobbin with that thread into the machine and press the Reset Bobbin button on the Main screen.

### ***To delete a low-bobbin configuration***

- Touch the bobbin name box and choose the specified thread name by touching it. Then touch the **Delete Bobbin** button.

### ***To edit a low-bobbin configuration***

- Touch the bobbin name box and choose the specified thread name by touching it. Then touch the **Edit Bobbin** button. Make any changes using the pop-up keyboard.

## Handlebar button options

Your Infinity came with labels for the handlebars because you can decide which functions you want on the right and left handlebars. For example, use the left handlebar for starting and stopping your quilting and the right handlebar for moving the needle up and down to pull up the bobbin thread, or vice versa. For more information about the handlebar labels, see *To attach labels to the handlebars* in the Installation and Setup section of this manual.

After you have placed the labels on the handlebars, use the handlebar customization settings to confirm your handlebar button choices and to make other customizations as to what the star and diamond buttons on the handlebars will do.

- ➡ **IMPORTANT:** However you configure the front handlebars, the rear handlebars are automatically configured the same way.

### ***To customize the handlebar buttons***

- Touch the **Settings** icon in the toolbar. Then touch the **Configure Handlebars** button. Return to the Main menu at any time by touching the **Home** button.

### ***To switch the left and right handlebar buttons***

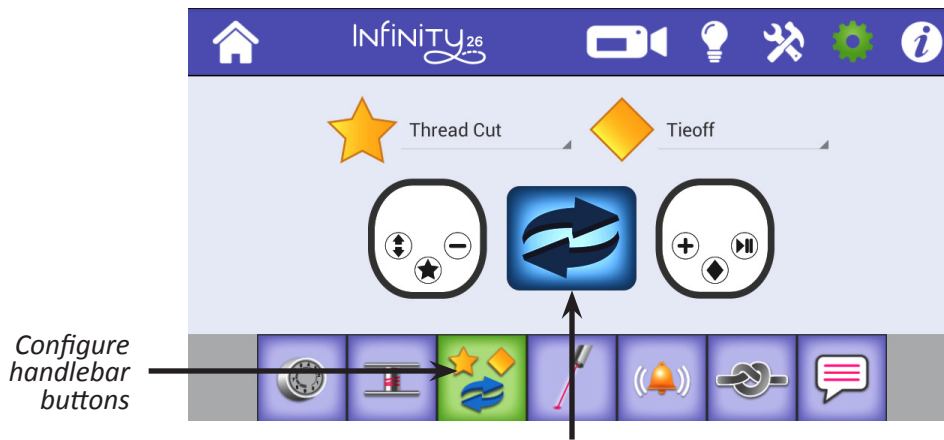

Press to switch the button configurations to match how you placed the labels on the handlebars. The left button image represents the left handlebar; the right button image represents the right handlebar.

- Press the double-arrow icon in the center of the screen to switch the options available for the left and right handlebars. Make sure that the handlebar labels are consistent with your selection.

**To configure the star and diamond buttons on the handlebars**

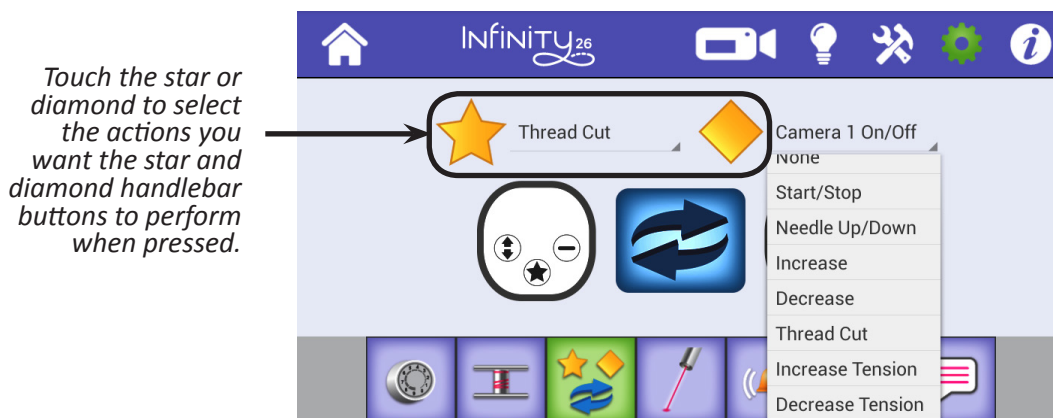

1. Select the down arrow next to the star or diamond to display a drop-down box with the options for the star and diamond buttons.
2. Touch your selection for the button.



The options for customizing the star and diamond buttons are:

Option	Action Performed
None	The button will not perform a function.
Start/Stop	Starts or stops stitching
Needle Up/Down	Performs a half stitch by cycling the needle up or down
Increase	Increases stitching speed
Decrease	Decreases stitching speed
Thread Cut	Cuts the bobbin thread
Increase Tension	Increases (tightens) the top tension
Decrease Tension	Decreases (loosens) the top tension
Camera (Front Display)	Displays video from the camera on the front display
Camera (Back Display)	Displays video from the camera on the back display
Tie Off	Performs a tie-off stitch

➡ **IMPORTANT:** If you use HQ Pro-Stitcher, it will override your settings for the star and diamond handlebar buttons for selected HQ Pro-Stitcher functions. For more information about using HQ Pro-Stitcher with the Infinity, refer to the HQ Pro-Stitcher user manual.

## Laser Lights

The Infinity comes equipped with two laser lights. One is by the needle to precisely show where the needle will enter the quilt. The other is the laser stylus that is used at the back of the machine for tracing pantographs. Turn on or off one or both of the lasers with the Laser settings.

For more information about installing the laser stylus, see *Install the Laser Light Stylus* in the *Installation and Setup* section of this manual.

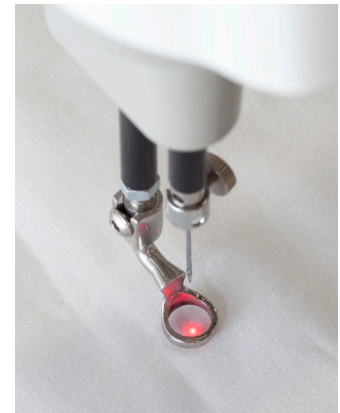

📺 **ONLINE:** For more information about quilting with pantographs, watch the video *Using Pantographs* at: <http://www.handiquilter.com/videos/hq-infinity/238/>.

### *To turn the lasers on or off*

- Touch the **Settings** icon in the toolbar. Then **touch** the Lasers button. Touch the light button to turn the laser on or off.





## Alarms

The alarm settings enable you to quickly turn on or off the alarms for the low bobbin, thread breaks, and when you are quilting faster than the stitch regulation can accommodate.

**Low-bobbin alarm:** Alerts you when the low-bobbin threshold has been reached, indicating you will soon run out of bobbin thread. For more information about the low-bobbin alarm, see *Low-Bobbin Alarm* above.

**Thread-break alarm:** Alerts you if the top thread breaks while quilting.

**Overspeed alarm:** Alerts you if you are moving the machine faster than 100% of motor capacity and therefore are quilting too fast for stitch regulation to work properly. Because of the high speeds of the Infinity can handle, you will most likely never encounter this alarm.

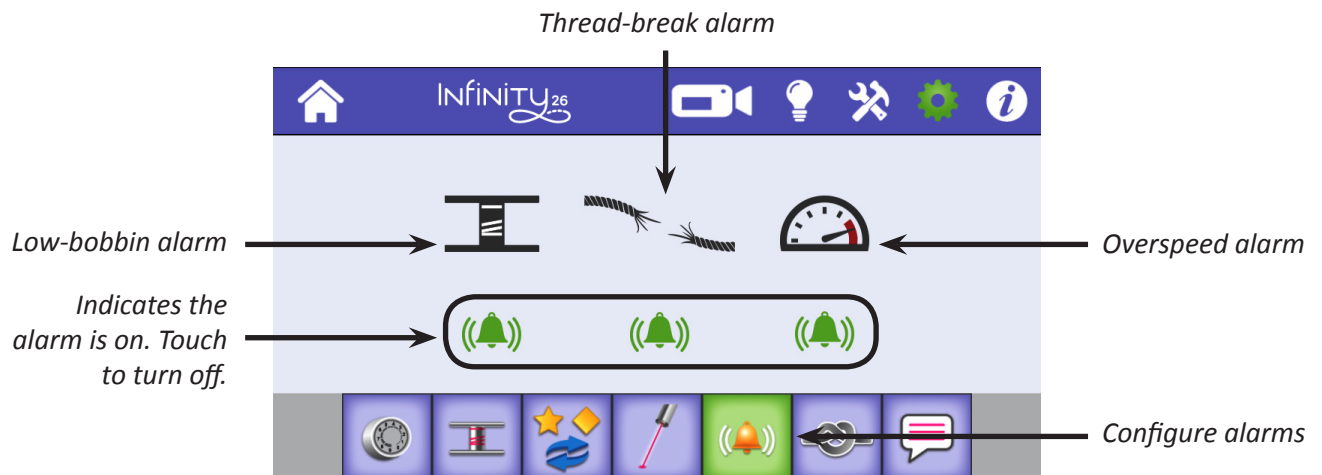

### To turn on or off alarms

- Touch the alarm button below the alarm to turn it on or off. It is on when it appears green with the sound-wave symbols. It is off when it appears purple.

## Tieoffs

Use tieoffs to begin and end your quilting to ensure the stitching doesn't come out. You can manually do the tieoffs by simply stitching in place for a few stitches, or let the Infinity perform a predefined number of quick, micro stitches for you. You can set the number of micro stitches from 0 to 10.

### To configure tieoffs

 **ONLINE:** To see how to tie off the thread when starting and ending quilting, watch the video *Starting and Stopping Quilting* at: <http://www.handiquilter.com/videos/hq-infinity/229/>.

- Touch the **Settings** icon in the toolbar. Then touch the **Configure Tieoffs** button. Press the plus (+) or minus (-) buttons to increase or decrease the number of micro stitches in a tieoff.

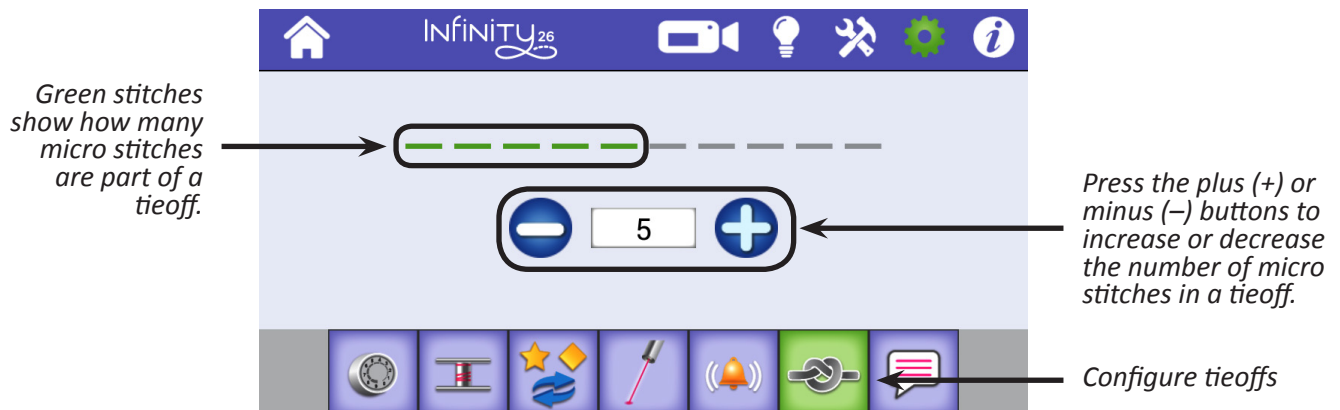

After you indicate how many stitches are in an automatic tieoff, use the Tieoff button on the Main screen to perform the tieoff. Touch the button and gently move the machine to perform the micro stitches.

## Set Language

 **NOTE:** This function may not be implemented in your software. When it is available, you will be able to download and update your machine's software using the Update function.

The language setting determines the language used on the Infinity information screens. The choices are English, French, German, and Spanish.

### To select a language

- Touch the **Settings** icon in the toolbar. Then touch the button to set the language. Press the down arrow to display the list of available languages. Touch your preferred language to select it.

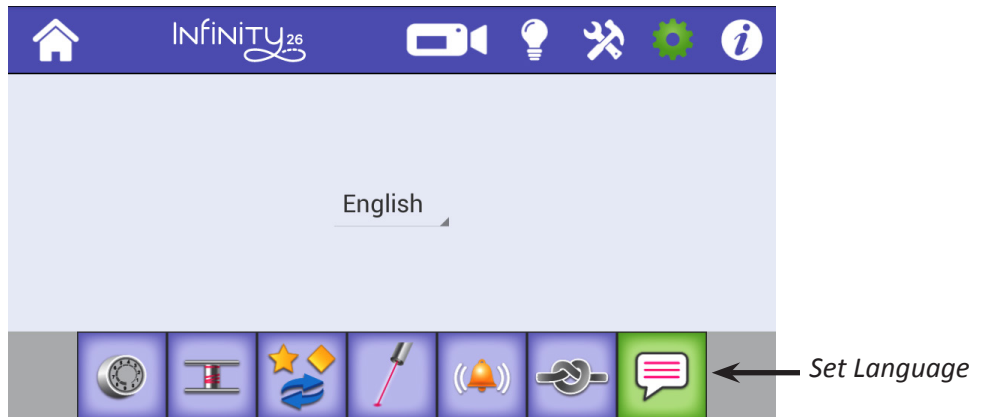

## Information Screens

The Information option provides system information and quick reference guides about your Infinity.

### *To see the needle and thread chart*

For quick reference, the Infinity has an on-screen guide for which size needle is appropriate for different weights of thread.

- Touch the **Information** icon in the toolbar. Then touch the **Needle** button.

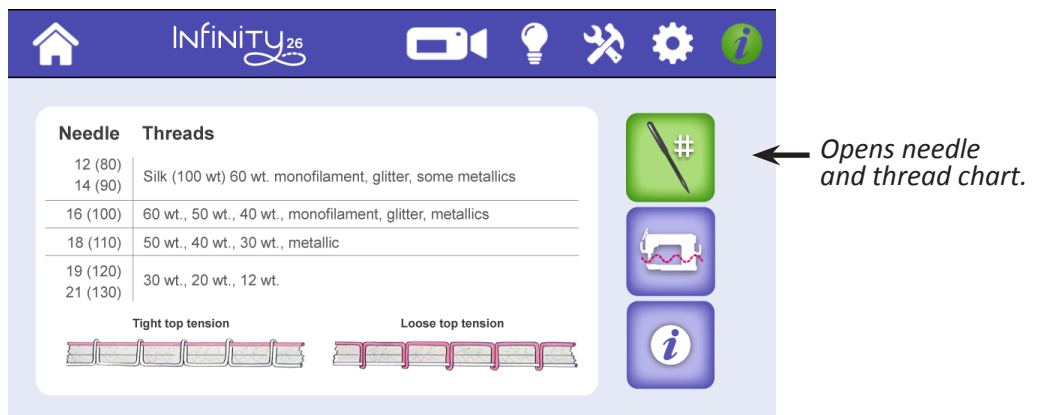

### *To see the machine threading diagram*

For quick reference, the Infinity has an on-screen guide that shows how to thread the machine. For more information about threading the Infinity, see *Threading the Machine* in the *Using Your Machine* section of this manual.

- Touch the **Information** icon in the toolbar. Then touch the **Machine Threading** button.

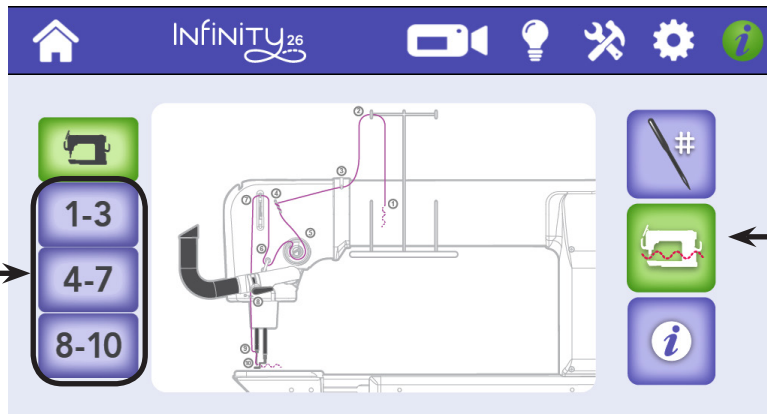

Shows close-up diagrams of threading the machine.

Opens machine threading diagrams.

Select one of the buttons along the left to see close-up diagrams of steps 1 through 3, 4 through 7, and 8 through 10.

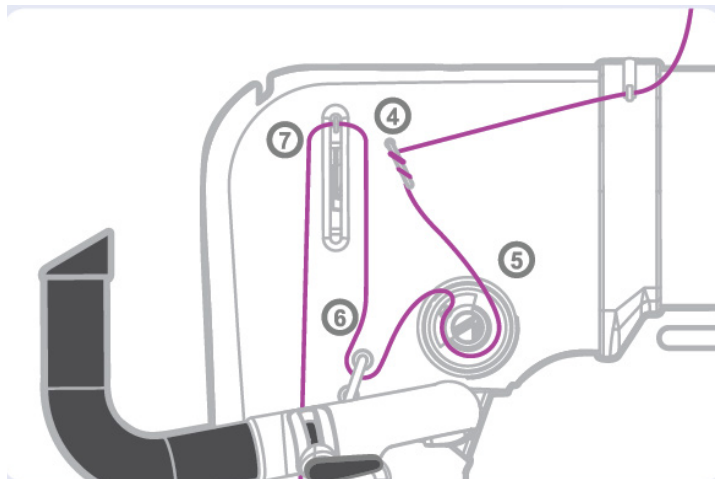
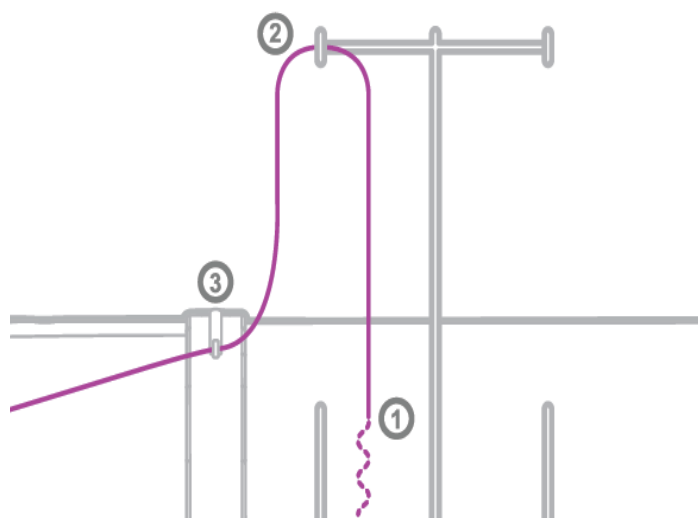

# 8-10

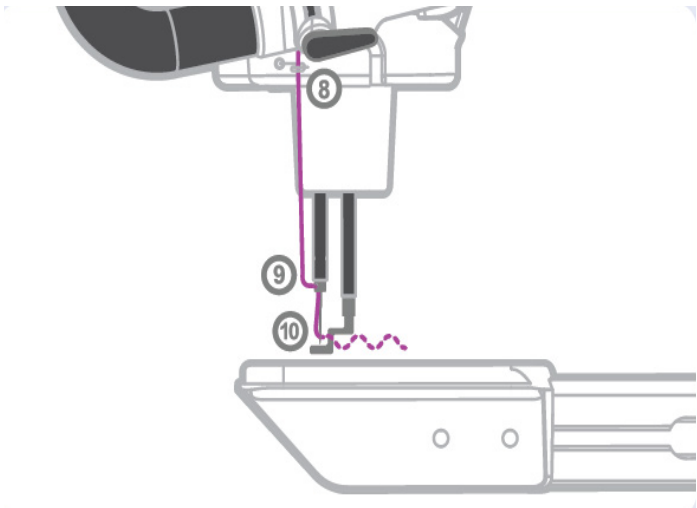

**To monitor system information about your machine**

You may need to provide system information to Handi Quilter or an authorized Handi Quilter representative when purchasing machine accessories or receiving technical assistance.

- Touch the **Information** icon in the toolbar. Then touch the **Information** button in the lower-right corner of the screen.



*Opens system information about the machine.*

Lifetime Stitch Count	Shows the lifetime stitch count for your machine
Lifetime Machine Time	Shows the cumulative time your machine has quilted
Machine Hardware Version	Shows the electronics board version number
Machine Software Version	Shows the machine's software version number
Screen Hardware Version	Shows the screen's version number
Screen Software Version	Shows the screen's software version number



# Machine Maintenance

## Clean and Oil Your Infinity

The only place where you need to regularly oil your machine is the bobbin hook assembly. Failure to keep the hook assembly lubricated can cause severe damage to the machine. We recommend that you oil the hook assembly with each bobbin change and before use if you haven't used the machine for a few days. A change in the sound of the machine while quilting also indicates that it may need to be oiled.

 **NOTE:** Internal oiling needs to be done when the machine is taken to a service technician for routine maintenance and cleaning, every 24 months or 15 million stitches (whichever comes first).

 **IMPORTANT:** Only use light sewing machine oil in the hook when oiling your machine.

### *To clean the bobbin area and oil the bobbin hook*

 **ONLINE:** To see how to clean and oil the bobbin area, watch the video *Maintaining Your Machine* at: <http://www.handiquilter.com/videos/hq-infinity/244/>.

1. Turn off the machine by powering off the front switch. Then remove the bobbin and bobbin case.
2. To clean the bobbin basket area, use canned air. This ensures that you don't damage any of the wires or the bobbin-thread cutter. Any dust or lint will be blown out of the openings surrounding the bobbin basket.

 **IMPORTANT:** Use short bursts of canned air. Be sure to also follow the specific instructions that come with the canned air.

3. Put a small drop of oil on the hook in the region where the bobbin basket assembly and the rotating hook meet. The oil will work its way back into the interlocking area of the hook and bobbin basket.

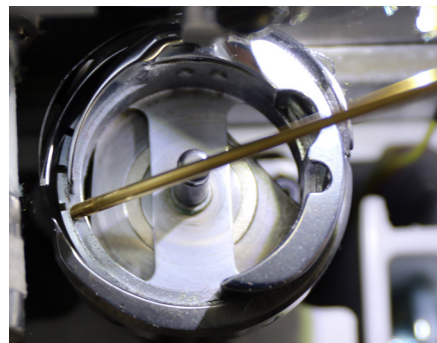

4. Replace the bobbin and bobbin case and turn on the machine.

### **Machine Quilting Tip: After oiling your machine**

---

After oiling, always sew on a scrap piece of fabric off to the side of the quilt as oil may cling to thread. Over oiling can cause excess dripping from the bobbin assembly.

### ***To clean the touch-screen display***

- Use a soft rag or microfiber cloth dampened with isopropyl alcohol and then gently wipe the display to remove any dust or fingermarks.
- △ **CAUTION:** Never use any chemicals to clean your display as this may negatively affect the display's touch-screen response.

## **Maintenance Schedule**

In addition to the ongoing cleaning and oiling maintenance, you should have your machine serviced by an authorized Handi Quilter representative every 24 months or 15 million stitches, whichever occurs first. They will take care of oiling and greasing internal parts and ensure the machine is in tip-top working order. When your machine reaches 15 million stitches, a pop-up message appears to remind you to have your Infinity serviced.

# Troubleshooting

You can correct many problems on your own. If you need additional help, contact your local, authorized Handi Quilter representative. You can also contact Handi Quilter technical solutions at 1-801-292-7988 or 1-877-MY-QUILT (697-8458).

First check the following:

1. The AC power cord is properly connected and both power switches are turned on.
2. Confirm that all cables are properly seated into their connections.
3. Turn off the machine completely. Wait for at least ten seconds and then it back on.

If the above checks did not solve the problem, refer to the information below.

Skipped Stitches	Corrective Measure(s)
The needle is damaged, dull, bent, or installed improperly	<ul style="list-style-type: none"> <li>• Replace the needle often, normally once or twice per day for continuous quilting or at least once per quilt. Use only the recommended needle system.</li> <li>• Always change the needle if the needle has struck any hard object such as a straight pin, etc. The tip of the needle can become damaged or burred, resulting in fabric damage as well as skipped stitches, thread breakage, or shredding.</li> <li>• Always change the needle if it has been hit, bumped or pulled off center while maneuvering the machine about the quilt. A slightly bent needle can be a major cause of skipped stitches.</li> </ul>
Incorrect needle size	<ul style="list-style-type: none"> <li>• Use the proper size of needle for the work and thread being used. Some battings and fabrics used in quilting may constrict or impede the thread passing through the front groove of the needle. This diminishes the loop lift required for stitch formation. Typically, a larger needle will solve the problem. However, using certain smaller sizes of needles and ball pointed needles solve some specific problems. You will need to experiment to determine which work best with your combination of fabric, thread, and batting.</li> </ul>
Fabric is too tight on the frame	<ul style="list-style-type: none"> <li>• Loosen the pole tension on the frame. Fabric that is rolled too tightly causes the fibers to separate and the fabric to bounce while quilting. This reduces the needle friction on the thread, resulting in a smaller thread loop.</li> </ul>
Thread tension too tight	<ul style="list-style-type: none"> <li>• Check bobbin case tension and then check top thread tension. (For more information about adjusting tension, see <i>Bobbin and Bobbin Tension</i> and <i>Easy-Touch Tension™</i> in the <i>Using Your Machine</i> section of this manual.)</li> </ul>

The needle is not positioned properly	<ul style="list-style-type: none"> <li>Position the needle properly to the needle bar. Inspect the position of the needle to make sure the needle is at the 6 o'clock position. When you stand directly in front of the needle (facing the bobbin case side of the machine), you will see the entire needle eye directly facing you. This is 6 o'clock position.</li> <li>Make sure (a) the needle is installed all the way into the needle bar to the needle-stop hole in the needle bar, (b) the long groove in the needle is toward the front (bobbin case side), and (c) the scarf (scooped out part of the back of the needle) is toward the back of the machine.</li> <li>The needle can sometimes be rotated to 5 o'clock (slightly right) or 7 o'clock (slightly left) to adjust for a more positive thread loop pickup by the hook point.</li> </ul>
Improper threading	<ul style="list-style-type: none"> <li>Ensure that the machine is threaded correctly.</li> </ul>
<b>The Needle Breaks</b>	<b>Corrective Measure(s)</b>
The needle is bent or not installed properly	<ul style="list-style-type: none"> <li>Replace the needle. Make sure that the needle is pushed into the needle bar clamp until it can go no farther. Visually check that it is up to the top of the stop/sight hole above the needle bar clamp screw. If the needle isn't installed properly, it can cause damage in the bobbin area and throat plate.</li> </ul>
The needle hits the throat plate	<ul style="list-style-type: none"> <li>Correctly position the needle, throat plate, or hopping foot. Replace with a new needle.</li> </ul>
<b>Stitches are Puckered</b>	<b>Corrective Measure(s)</b>
The tension is not balanced	<ul style="list-style-type: none"> <li>Balance the tension of the needle thread after ensuring the bobbin tension is adjusted correctly. (For more information about adjusting tension, see <i>Bobbin and Bobbin Tension</i> and <i>Easy-Touch Tension™</i> in the <i>Using Your Machine</i> section of this manual.)</li> </ul>
Needle too large for quilting fabric	<ul style="list-style-type: none"> <li>Replace the needle with a size better suited for the fabric.</li> </ul>
<b>Poor Stitch Quality</b>	<b>Corrective Measure(s)</b>
The tension is not balanced	<ul style="list-style-type: none"> <li>Balance the tension of the needle thread after ensuring the bobbin tension is adjusted correctly. (For more information about adjusting tension, see <i>Bobbin and Bobbin Tension</i> and <i>Easy-Touch Tension™</i> in the <i>Using Your Machine</i> section of this manual.)</li> </ul>
Bobbin case is damaged, corroded, dirty, etc.	<ul style="list-style-type: none"> <li>Since thread slides over the surface of the bobbin case at a high speed, make sure the case is free of any lint or foreign matter that could impede thread passage through the machine.</li> </ul>

Moving the machine too fast for needle speed selected (Manual mode)	<ul style="list-style-type: none"> <li>Synchronize machine movement and needle speed to get roughly 8 to 10 stitches per inch. Elongated stitches are an indication of moving the machine too fast for the current speed.</li> </ul>
<b>Tension is Poor</b>	<b>Corrective Measure(s)</b>
Lint caught under the tension spring in the bobbin	<ul style="list-style-type: none"> <li>If using short staple threads, inexpensive, or industrial threads, or coated threads, lint and other material will build up under the tension spring and begin to lift the spring, reducing the spring's ability to compress against the thread. Insert a needle or business card under the spring and clear out the lint. The bobbin tension will return fairly close to its preset tension. Test the tension before quilting.</li> </ul>
<b>Hand Wheel Won't Rotate</b>	<b>Corrective Measure(s)</b>
Thread is entangled and caught in the hook	<ul style="list-style-type: none"> <li>There may be a thread lock. With the machine on, use the on-screen hand wheel to break the thread lock. Quickly move your finger down and up several times. If this doesn't solve the problem, turn the machine off and use the handwheel at the back of the machine to resolve the thread lock.</li> </ul>
<b>Thread Nests Under Quilt</b>	<b>Corrective Measure(s)</b>
Not enough tension on top thread	<ul style="list-style-type: none"> <li>Check that the machine is threaded correctly. Make certain that the thread is flossed snugly in place between the two tension discs. If the machine is threaded correctly, tighten top tension by rotating the tension knob clockwise. (For more information about adjusting tension, see <i>Bobbin and Bobbin Tension</i> and <i>Easy-Touch Tension™</i> in the <i>Using Your Machine</i> section of this manual.)</li> </ul>
Improper threading	<ul style="list-style-type: none"> <li>Refer to threading diagram and threading instructions.</li> </ul>
<b>Thread Backlash</b>	<b>Corrective Measure(s)</b>
Bobbin thread tangles within the bobbin case, tangles and winds onto the hook spindle, or occasionally forms loops on the bottom of the quilt.	<ul style="list-style-type: none"> <li>The bobbin should sit in the bobbin case such that one side is very minimally above the edge of the bobbin case and if you lightly press down on the bobbin, it descends slightly into the case. To adjust the backlash spring, place the bobbin in the case and hold it with the bobbin facing up. Then use a tiny screw driver to adjust the screw on the outside front shiny surface of the bobbin case (not the screw inside the bobbin case). Turn the screw counterclockwise to raise the backlash spring (and raise the bobbin) or turn it clockwise to lower the backlash spring (and lower the bobbin). After making an adjustment, reinsert the bobbin into the machine, bring up the bobbin thread, and test stitching. Make additional adjustments if necessary.</li> </ul>

<b>Hard to Guide Machine</b>	<b>Corrective Measure(s)</b>
Carriage wheels not centered on track	<ul style="list-style-type: none"> <li>Center the carriage wheels on top of the continuous track. Check that the machine carriage has not jumped the track.</li> </ul>
Thread caught in wheels	<ul style="list-style-type: none"> <li>Remove all thread or debris in wheels. Check that the tracks are free of lint and threads.</li> </ul>
<b>Motor Fails to Run</b>	<b>Corrective Measure(s)</b>
On/Off switch turned off	<ul style="list-style-type: none"> <li>Make sure that both power switches are turned on. First turn on the rear power switch (to the 1 position); then turn on the red power button on the front-left side of the machine.</li> </ul>
Machine not receiving power	<ul style="list-style-type: none"> <li>Check that the power connector is securely plugged into the back of the machine and the three-prong end is plugged into the power source.</li> </ul>
<b>Uneven Quilt Design</b>	<b>Corrective Measure(s)</b>
Take-up rollers may be bowed or bent	<ul style="list-style-type: none"> <li>Make certain the fabric is not rolled too tight, causing the poles to bow. Check that poles are inserted completely together with the push pins engaged so bowing won't occur.</li> </ul>
Leaders are stretched or worn	<ul style="list-style-type: none"> <li>If fabric is beginning to stretch or fray, contact Handi Quilter to purchase replacement leaders.</li> </ul>
<b>Thread Breaks</b>	<b>Corrective Measure(s)</b>
Thread is poor quality or may have severe twisting or thread rot	<ul style="list-style-type: none"> <li>Look for severe twisting of threads when approximately 12 to 15 inches has been pulled off, with the ends pinched together. Cotton threads are particularly susceptible to dry rot or wet rot which makes thread brittle. Do not use poor quality thread, or thread that is rotted or brittle.</li> </ul>
Top and bobbin tensions not balanced	<ul style="list-style-type: none"> <li>Balance the tension of the needle thread after ensuring the bobbin tension is adjusted correctly. (For more information about adjusting tension, see <i>Bobbin and Bobbin Tension</i> and <i>Easy-Touch Tension™</i> in the <i>Using Your Machine</i> section of this manual.)</li> </ul>

The machine head has been threaded incorrectly or thread spools are not positioned correctly	<ul style="list-style-type: none"> <li>• Check that the machine is threaded correctly.</li> <li>• Inspect for accidental double wrapping of thread on thread guides.</li> <li>• Inspect the thread mast, making sure the eyelets of the mast are directly over the spools.</li> <li>• Inspect the vertical positioning of the thread cones. Tipped cones can dramatically affect thread tension and can cause breakage.</li> </ul>
Debris in tension discs	<ul style="list-style-type: none"> <li>• Inspect for particles and remove any fuzz or debris.</li> </ul>
Bobbin rotation is not smooth	<ul style="list-style-type: none"> <li>• Change the bobbin. The slightest hesitation of the bobbin rotation can be the cause of dramatic tension change and thread breakage.</li> </ul>
Needle is burred, bent or dull, or installed incorrectly	<ul style="list-style-type: none"> <li>• Change the needle at least once per quilt. Make sure the needle is installed to the top of the stop hole in the needle bar.</li> </ul>
Needle not suitable for thread	<ul style="list-style-type: none"> <li>• Replace the needle to one better suited for the thread. Use the proper size needle.</li> </ul>
Hesitating too long at one point in quilting motif	<ul style="list-style-type: none"> <li>• Move more quickly so stitches don't overlap or build up. When starting the machine, begin moving immediately. Sewing in one place too long will cause the thread to break.</li> </ul>
Improper needle/hook relationship	<ul style="list-style-type: none"> <li>• Machine timing needs to be checked. Consult an authorized Handi Quilter technician.</li> </ul>
Damage or burr at needle hole of throat plate or other thread handling part	<ul style="list-style-type: none"> <li>• If thread is shredding at the throat plate, check for burrs or jagged edges. Gently rub with metal cloth to remove the sharp edge. Consult a repair technician to polish any hard-to-reach or delicate areas, or if the burr is inside the throat.</li> </ul>
Wrong type of needle	<ul style="list-style-type: none"> <li>• Use only the needles recommended by Handi Quilter (134 MR, sizes 12 through 21).</li> </ul>
Other possible problems	<ul style="list-style-type: none"> <li>• Needle too close to hook, causing friction and possible collision of hook point and needle (causing broken thread).</li> <li>• Needle plate damage</li> <li>• Hook damage</li> <li>• Broken needles or damaged needle bar clamp</li> </ul>



<b>Nothing visible on the display</b>	<b>Corrective Measure(s)</b>
Display cables unplugged	<ul style="list-style-type: none"><li>• Locate the black cables that plug into the touch-screen display and connect to the side of the machine. Make sure both ends are plugged in securely.</li></ul>

 **NOTE:** If the troubleshooting tips do not eliminate the problem, please consult an authorized HQ representative.

# Appendix 1

## **Federal Communications Commissions (FCC) Declaration of Conformity (For USA Only)**

Responsible Party: Handi Quilter, Inc.  
501 North 400 West  
North Salt Lake, UT 84054

declares that the product

Product Name: HQ Infinity

complies with Part 15 of the FCC Rules. Operation is subject to the following two conditions: (1) this device may not cause harmful interference, and (2) this device must accept any interference received, including interference that may cause undesired operation.

This equipment has been tested and found to comply with the limits for Class B digital device, pursuant to Part 15 of the FCC Rules. These limits are designed to provide reasonable protection against harmful interference in a residential installation. This equipment generates, uses, and can radiate radio frequency energy and, if not installed and used in accordance with the instructions, may cause harmful interference to radio communications. However, there is no guarantee that interference will not occur in a particular installation.

If this equipment does cause harmful interference to radio or television reception, which can be determined by turning the equipment off and on, the user is encouraged to try to correct the interference by one or more of the following measures:

- Reorient or relocate the receiving antenna.
- Increase the separation between the equipment and receiver.
- Consult the dealer or an experienced radio/TV technician for help.

Changes or modifications not expressly approved by the manufacturer or local sales distributor could void the user's authority to operate the equipment.

## **Canadian Department of Communications Compliance Statement (For Canada Only)**

This digital apparatus does not exceed the Class B limits for radio noise emission from digital apparatus as set out in the interference-causing equipment standard entitled "Digital Apparatus", ICES-003 of the Department of Communications.

## **Radio Interference (Other than USA and Canada)**

This machine complies with EN55022 (CISPR Publication 22) /Class B and AUS/NZ 55022/Class B.

# Appendix 2: QR Codes for HQ Infinity Videos

The following QR codes enable you to use your smart phone to quickly load the HQ Infinity Getting Started videos. Download a QR reader from the application store for your phone. Then use the QR reader to scan the QR code. The video will then play on your smart phone.

## Setting Up the Frame

<http://www.handiquilter.com/videos/hq-infinity/209/>



## Installing the Front Handlebars

<http://www.handiquilter.com/videos/hq-infinity/210/>



## Installing the Rear Handlebars

<http://www.handiquilter.com/videos/hq-infinity/211/>



## Adjusting the Position and Angle of the Handlebars

<http://www.handiquilter.com/videos/hq-infinity/212/>



## Installing the Front Display

<http://www.handiquilter.com/videos/hq-infinity/213/>



## Installing the Rear Display

<http://www.handiquilter.com/videos/hq-infinity/214/>



## Installing the Thread Tray

<http://www.handiquilter.com/videos/hq-infinity/216/>



## Installing the Video Camera

<http://www.handiquilter.com/videos/hq-infinity/218/>



## Installing the Ruler Base

<http://www.handiquilter.com/videos/hq-infinity/219/>



## Installing the Laser Stylus

<http://www.handiquilter.com/videos/hq-infinity/221/>



## Changing the Needle

<http://www.handiquilter.com/videos/hq-infinity/222/>



## Changing the Hopping Foot

<http://www.handiquilter.com/videos/hq-infinity/223/>



## Inserting the Bobbin

<http://www.handiquilter.com/videos/hq-infinity/225/>



Testing and Adjusting Bobbin Tension  
<http://www.handquilter.com/videos/hq-infinity/248/>



Inserting the Bobbin Case  
<http://www.handquilter.com/videos/hq-infinity/227/>



Adjusting the Top-thread Tension  
<http://www.handquilter.com/videos/hq-infinity/233/>



Threading the Machine  
<http://www.handquilter.com/dash/videos/video/228/>



Loading a Quilt  
<http://www.handquilter.com/videos/hq-infinity/247/>



Using the Bobbin Winder  
<http://www.handquilter.com/videos/hq-infinity/245/>



Starting and Stopping Quilting  
<http://www.handquilter.com/videos/hq-infinity/229/>



## Using the Bobbin Thread Cutter

<http://www.handiquilter.com/videos/hq-infinity/232/>



## Free-Motion Quilting

<http://www.handiquilter.com/videos/hq-infinity/246/>



## Micro Quilting

<http://www.handiquilter.com/videos/hq-infinity/239/>



## Using Rulers and Templates

<http://www.handiquilter.com/videos/hq-infinity/220/>



## Using Pantographs

<http://www.handiquilter.com/videos/hq-infinity/238/>



## Using the Couching Feet

<http://www.handiquilter.com/videos/hq-infinity/224/>



## Using the HQ Pro-Stitcher Tablet Computer With the Infinity

<http://www.handiquilter.com/videos/hq-infinity/230/>



Using the Touch-Screen Displays  
<http://www.handiquilter.com/videos/hq-infinity/231/>



Using Manual Stitching Mode  
<http://www.handiquilter.com/videos/hq-infinity/234/>



Using Cruise Stitch Regulation  
<http://www.handiquilter.com/videos/hq-infinity/235/>



Using Precision Stitch Regulation  
<http://www.handiquilter.com/videos/hq-infinity/236/>



Controlling the Lights on the Infinity  
<http://www.handiquilter.com/videos/hq-infinity/242/>



Setting and Using the Quilting Alarms and Stitch Counter  
<http://www.handiquilter.com/videos/hq-infinity/241/>



Updating the Software on the Infinity  
<http://www.handiquilter.com/videos/hq-infinity/243/>





Using the Low-Bobbin Alarm  
<http://www.handiquilter.com/videos/hq-infinity/240/>





501 N 400 W  
North Salt Lake, UT 84054

Phone: 801-292-7988; 877-697-8458  
Fax: 801-294-3011  
E-mail: sales@handiquilter.com  
www.HandiQuilter.com

Warranty issues should, whenever possible, be first submitted to the Representative who completed your service/training certificate. These representatives have been selected for their dedication to customer satisfaction and superior service. They provide follow-up advice, training, service, accessories and other services.

Representatives may offer their own warranties in addition to those offered by the manufacturer, but do not obligate the manufacturer.

## HQ QUILTING MACHINE LIMITED WARRANTY

Handi Quilter, Inc. (hereinafter HQ) offers a limited warranty on the HQ QUILTING MACHINE (hereinafter "Machine") to be free of defects in workmanship and materials under normal use upon the terms and conditions hereinafter set forth:

- (a) **90 day Limited Warranty** - During the first 90 days from date of purchase, HQ will repair any manufacturing defect without charge for parts or labor. All subsequent warranties include parts costs only.
- (b) **10 year Limited Manufacturer's Warranty.** HQ warrants the sewing head is free of casting or machining imperfections causing product failure. This warranty does not extend to mechanical or electronic/electrical parts, which are covered under a separate warranty, or consequential damage to the head caused by mechanical or electronic/electrical part failures beyond their warranty period.
- (c) **5 year Mechanical Warranty** For any mechanical failure within this period, manufacturer will provide free replacement parts, customer pays for labor and shipping. See warranty exclusions.
- (d) **5 year electronic/electrical warranty.** The electric/electronic components are warranted to be free from manufacturing defects for 5 year from the date of purchase. If any defect is reported within this period, manufacturer will provide free replacement parts, customer pays for labor and shipping. The 5 year electronic/electrical warranty will be invalid if the machine is left plugged into a power source when not in use.

The limited warranty stated in sections (b), (c) and (d) above shall be limited solely to the replacement of parts which, in the opinion of HQ, are defective in workmanship or material and are returned to HQ, or an authorized repair facility, or such other point or place that may be designated by HQ. All other costs, including cost of freight and shipment for repair under this warranty, shall be the customer's costs.

This warranty shall be in force only for the original purchaser.

The machine registration card must be completed and received by HQ before warranty is valid.

### Warranty Exclusions

HQ shall have no obligation for any claim under this warranty if the machine has been misused, abused, neglected, damaged in transit or has been altered from the standard specifications established by HQ, or if proper maintenance and lubrication have not been timely performed.

No warranties extend beyond the express warranty offered. HQ disclaims all other warranties, express or implied, regarding the Products, including any implied warranties of merchantability or fitness for a particular purpose. In the United States, some laws do not allow the exclusion of the implied warranties.

#### Specific exclusions of warranty limitations include, but are not limited to, the following:

- General, consequential, incidental or special damages including damage to fabric or material, the cost of rework or lost profits, the cost of installation or removal of any Products, and any inspection, testing, or redesign caused by any defect or by the repair or replacement of Products arising from a defect in any Product.
- Products which are received by HQ improperly packaged, altered, or physically damaged.
- Counterfeit or altered label(s) or stickers.
- Broken pins on connectors.
- Stripped screws or nuts.
- Connector(s) damaged, cracked, missing or broken.
- Missing, torn or punctured seal(s).

- Any use besides machine quilting applications using customary fabrics, threads and accessories.
- Operator error in the customary use of the Product.
- Internal adjustments, tampering or parts replacement done by anyone except authorized Representatives or customers specifically authorized by Handi Quilter Customer Support or warranty repair personnel on a case by case basis.

The warranty does not cover and the user assumes the risk of and there is hereby excluded any liability to HQ for failure, defects, loss, deterioration, personal injury or damage which are due to: (1) ordinary wear and tear or exposure, (2) abuse, misuse, negligence, or (3) use of parts not authorized by HQ.

In no event shall HQ be liable to the purchaser of the Machine or to third parties for special or consequential damages, including, but not limited to, death or personal injuries.

HQ does not assume, or authorize any person to assume on its behalf, any other obligation of liability other than that set forth herein.

Some states do not allow exclusion of limitation of incidental or consequential damages, so above limitation or exclusion may not apply. This warranty gives the purchaser specific legal rights and the purchaser may also have other rights, which may vary for State to State.

### **Exclusive Remedy**

Remedy is limited to the repair or replacement of the defective Product. HQ may elect which remedy or combination of remedies to provide at its sole discretion and shall have a reasonable time, after determining that a defective Product exists, to repair or replace the defective product. Replacement Product may be from new or serviceable used parts. HQ's warranty applies to repaired or replaced Products for the balance of the applicable period of the original warranty or ninety days from the date of shipment of a repaired or replaced Product, whichever is longer.

HQ's entire liability for any defective Product shall in no event exceed the purchase price for the defective Product. This limitation applies even if Handi Quilter cannot or does not repair or replace any defective Product.

### **Warranty Claims**

Service under the above warranties may be obtained by returning the quilting machine, with proof of purchase, to the authorized Representative from whom the machine was purchased, a local Representative, or to Handi Quilter Customer Support.

**Any product to be returned to the factory, either by customers or Representatives, must be accompanied by a Return Material Authorization Number (RMA).** RMAs may be obtained by email (sales@handiquilter.com) or by calling customer support toll free at 1-877-697-8458. If it is determined that the Product may be defective, an RMA number will be issued with instructions for Product return. An unauthorized return (a return without an RMA number) will be shipped back to customer at customer's expense. Authorized returns are to be shipped prepaid and insured in an approved shipping container. The original box and packaging materials should be kept for storing or shipping.

### **Shipping Costs**

Shipping is the responsibility of the customer.

### **Product Service and Maintenance**

Replace needles every 2 to 4 hours (1 to 2 per large quilt) and lubricate bobbin hook every 3 to 4 hours of use. Periodically check the thread tensioner. Use a small brush to clean out all lint, loose thread or obstructions from the bobbin hook.

Servicing is recommended annually from a qualified Representative. Servicing will cover belt tensioning, encoder positioning, bearing retainers, hook axial play and timing, presser and needle-bar adjustment and internal lubrication to take-up lever, hopping foot levers, bushings/bearings.

Handi Quilter, Inc.  
Customer Service Department  
501 N. 400 West  
North Salt Lake, Utah 84054

11/01/14

**Warranty Registration**

11/01/14

Return this registration card within 30 days of purchase or if you prefer, register online at <http://www.handiquilter.com/warranty>.

MAIL TO: Handi Quilter, Inc.  
Warranty Registration  
501 N 400 W  
North Salt Lake, Utah 84054

**WARRANTY REGISTRATION CARD**

The HQ Quilting Machine warranty is 10 years manufacturer's warranty on casting and machining of the case, 5 years mechanical, and 5 years electronic/electrical. Check with your local HQ Representative for details on getting service or making warranty claims.

Cut along dotted line and mail or fax this registration information within 30 days of purchase.

Customer Name: \_\_\_\_\_

Company/Business Name (if any): \_\_\_\_\_

Address: \_\_\_\_\_

City: \_\_\_\_\_ State: \_\_\_\_\_ Zip: \_\_\_\_\_

Day Phone: (\_\_\_\_) \_\_\_\_\_ Evening Phone: (\_\_\_\_) \_\_\_\_\_

Fax: (\_\_\_\_) \_\_\_\_\_ Email: \_\_\_\_\_

HQ Quilting Machine Model (circle one): HQ Avanté HQ Fusion HQ Infinity HQ Sweet Sixteen

HQ Serial Number: \_\_\_\_\_ Order Number (5 digits): \_\_\_\_\_

Purchase Date: \_\_\_\_\_ Date Machine Received: \_\_\_\_\_

Location of Purchase: \_\_\_\_\_ City: \_\_\_\_\_ State: \_\_\_\_\_

**Type of use intended:**

- Home/Personal
- Some commercial
- Other
- Shared w/ Friends
- Mostly commercial

**Level of machine-quilting skills:**

- Novice
- Intermediate
- Experienced

**Skill adjusting sewing machines:**

- Novice
- Intermediate
- Experienced

This page was intentionally left blank.

# HQ Quilting Machine New Owner and Training Checklist and Certificate

You are entitled to a one-time free introductory training class on the use of your HQ quilting machine as well as free adjustments for 60 days and any repairs covered by the warranty. Present this checklist to your authorized HQ quilting machine Rep to receive these free services.

## Table

- How to adjust length (Not applicable for HQ Sweet Sixteen)
- How to adjust height

## Machine Setup

- Identify the main parts of the machine
- Ensure machine is properly mounted to the carriage or table
- Check all cable connections
- Ensure power outlet is available and does not cause a trip hazard
- Recommend and explain the importance of a power strip with surge protection
- Ensure the table is level
- Show how to wind a bobbin (*including how to adjust the tensioner and the capacity lever*)
- Show how to load a quilt

## Machine Operation (all machines)

- How to turn the machine on and off (both switches)
- How to change the needle
- How to change the Handi Feet
- How to properly thread the machine
- How to set the bottom tension (*bobbin case*); teach the drop test
- How to set the upper tension with Easy-Touch Tension
- How to bring up the bobbin thread
- How to tie off
- How to use the menus: explain each menu
- How to adjust lighting

## Machine Operation

### (HQ Avanté, HQ Fusion, HQ Infinity)

- How to switch between stitch regulation and manual mode
- How to set the speed in manual mode
- How to set the stitches-per-inch in stitch regulation
- How to use Cruise stitch regulation
- How to use Precision stitch regulation
- How to use the front and rear handlebars
- How to use the laser pointer stylus and the included pantograph
- Review features unique to the purchased machine

Retain a copy for your records.



Designed by a Quilter, for Quilters.®

## HQ Sweet Sixteen only

- How to use the foot control
- How to use the color touch screen
- How to use the functions of the touch screen
- How to set the presets and My Speed
- How to use needle up/down and tie-off buttons

## Machine Maintenance

- How to oil the bobbin hook: where, how, and when
- How to clean the bobbin hook area
- How to clean wheels and tracks (*where applicable*)

## IMPORTANT: Read before signing

By signing this training checklist you are acknowledging you have been personally instructed in the operation of the Handi Quilter machine you purchased. Additional training by this HQ Retailer or any other HQ Retailer may result in being charged for additional instruction.

Customer Name \_\_\_\_\_

Customer Signature \_\_\_\_\_

Training Date \_\_\_\_\_

Trainer Name \_\_\_\_\_

Rep Signature \_\_\_\_\_

HQ Rep Business Name \_\_\_\_\_

Business City and State/Province \_\_\_\_\_

HQ Quilting Machine Model (circle one)

HQ Avanté HQ Fusion HQ Infinity HQ Sweet Sixteen

Machine Serial Number \_\_\_\_\_

**Representative:** To register training services provided, return completed and signed certificate by FAX (1-801-294-3011) or MAIL:

**Handi Quilter**  
501 North 400 West  
North Salt Lake, UT 84054

Cut along dotted line and mail or fax this registration information within 30 days of purchase.

This page was intentionally left blank.





Handi Quilter, Inc.  
501 N 400 W  
North Salt Lake, UT 84054

1-877-MY-QUILT (697-8458) • [www.HandiQuilter.com](http://www.HandiQuilter.com)

*HQ Infinity™ is part of the family of innovative quilting products from Handi Quilter®*



PRINTED 11 / 01 / 2014

© 2014 Handi Quilter, Inc. All rights reserved. Printed in the U.S.A.